

aydınlatma, ışığı ustaca giydirmektir...



2 0 1 3

STUDIO  
BESTAR  
LIGHTING

## TEKNİK AÇILIMLAR



Height for the article  
Ürün yüksekliği



Indoor using  
Ev içi kullanım



Outdoor using  
Dış kullanım



Cutting hole in mm  
for the article  
Ürün için kesim alanı



Surface size for the article  
Tavanın yüzey büyüklüğü



Using on the ceiling  
Tavan kullanımı



Lamp for the article,  
available wattage  
Ampülün watt miktarı



Using on the ground  
Zemin kullanımı



Protection - class I,  
Earth connection  
Koruyucu, sınıf I,  
Topraklı



Protection - class II,  
Double insulation  
Koruyucu, sınıf II,  
Çift yalıtımlı



Protection - class III,  
Low-voltage  
Koruyucu, sınıf III,  
Düşük voltaj



Light moving angle  
Işığın hareket açısı



Lamp working voltage  
Işığın voltaj miktarı



Lampholder type  
Duy tipleri



Rotation angle  
Açı rotasyonu



Dark Light  
Düşük aydınlatma



Material for the article  
Ürününün materyali



Changing lamp  
without clip  
Değiştirilebilir ampül

## RENK SKALASI



W - White  
Beyaz



B - Black  
Siyah



SG - Silver Grey  
Gümüş Gri



EG - Europa Grey  
Avrupa Gri



PB - Pearl Black  
Siyah İnci



GAB - Green Antique Brass  
Yeşil Antika Pirinç



RAB - Red Antique Brass  
Kırmızı Antika Pirinç



CP - Chrome  
Krom



NM - Nickel Matte  
Nikel Mat



GM - Gold Matte  
Altın Mat



G - Gold  
Altın



AP - Aluminium Polished  
Alüminyum Parlak

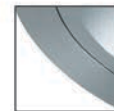

AM - Aluminium Matte  
Alüminyum Mat



SS - Stainless Steel  
Paslanmaz Çelik

## AYDINLATMA, IŞIĞI USTACA GİYDİRMEKTİR...

İyi hizmet ve kalite; teknolojinin bize kazandırdığı en önemli iki faktör. Bu nedenle kuşkusuz yaşamımız oldukça kolaylaştı.

Mum ışığından, seçmeye zorlandığımız geniş bir aydınlatma ürünlerine sahibiz bugün. Öylesine ki içinde yaşadığımız ev ve ofislerden dış mekan aydınlatmasına kadar...

Bestar ile başladığımız aydınlatma serüvenine; bünyemize Bestyle markasını da katarak Studio Bestar Lighting çatısı altında devam ediyoruz.

İşlev, teknik ve estetik bileşkesini ustaca yansıtan Studio Bestar Lighting ürünleri, doğru aydınlatma ihtiyacı olan her birey ile doğru köprüyü kurarak çözümler sunuyor.

Teknolojik gelişimin hızlı takipçisi olarak Studio Bestar Lighting aydınlatma serüvenindeki yükselen grafiğini sürdürüyor...

## İÇİNDEKİLER

<b>KRİSTAL SPOTLAR</b>	<b>04-13</b>
<b>HALOJEN CAM SPOTLAR</b>	<b>14-27</b>
<b>HALOJEN SPOTLAR</b>	<b>28-45</b>
<b>PROFESYONEL AYDINLATMALAR</b>	<b>46-103</b>
<b>LED AYDINLATMA</b>	<b>104-139</b>
<b>FİBER OPTİK</b>	<b>140-143</b>
<b>HARİCİ ARMATÜR</b>	<b>144-157</b>
<b>BANT ARMATÜR</b>	<b>158-161</b>
<b>TAVAN ARMATÜR</b>	<b>162-165</b>
<b>VINTAGE SPOT</b>	<b>166-177</b>
<b>RAY ve AKSESUARLAR</b>	<b>178-185</b>



S T U D I O  
*B*ESTAR  
L I G H T I N G

*B*ESTAR.com.tr

## KRISTAL SPOTLAR / APLİKLER

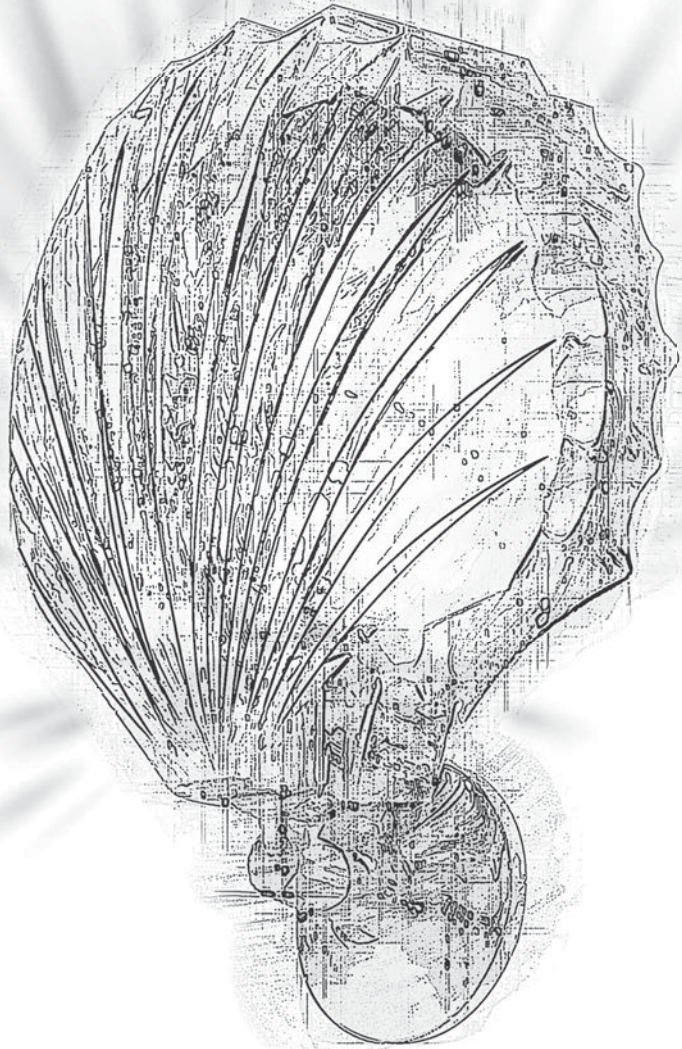
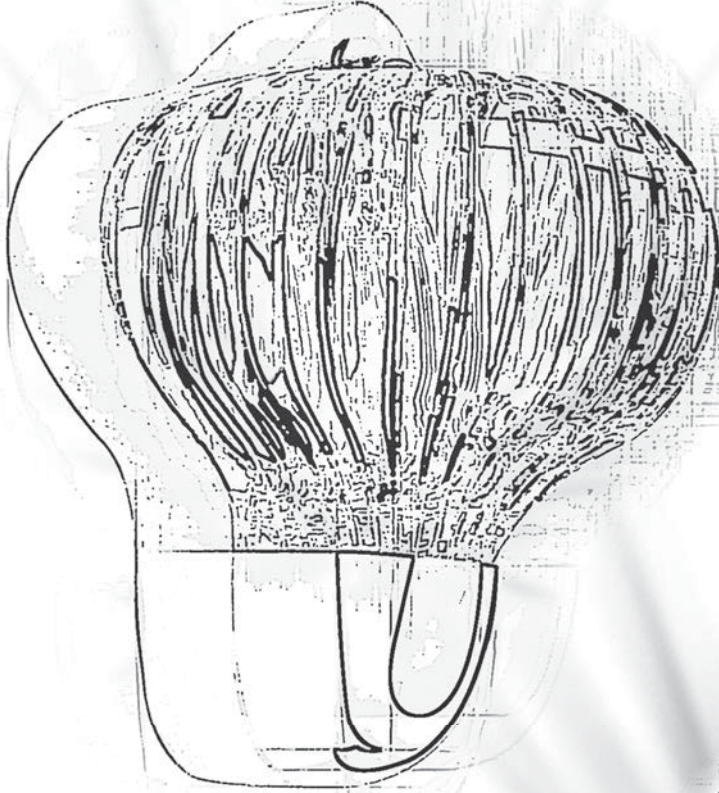

# KRİSTAL APLİKLER

03.4396

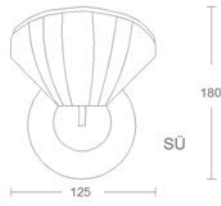

03.4387

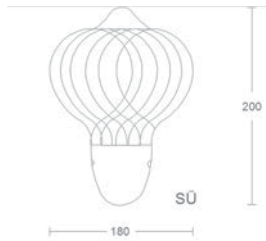

03.4395

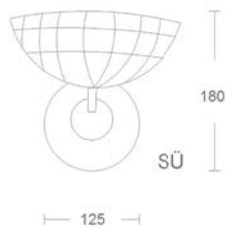

## Kristal Zerafeti



- Krom Kaplamalı Kaide
- Kristal Cam
- Elektronik Trafoya Uygun
- Duy: G4
- Ampül: Halojen Kapsül
- MAX:10-20W
- Kullanım Alanları: Villa, Ev, Ofis, Mağaza, Showroom, Galeri.



03.4400

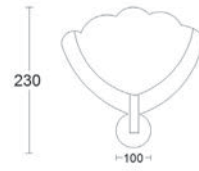

03.4410

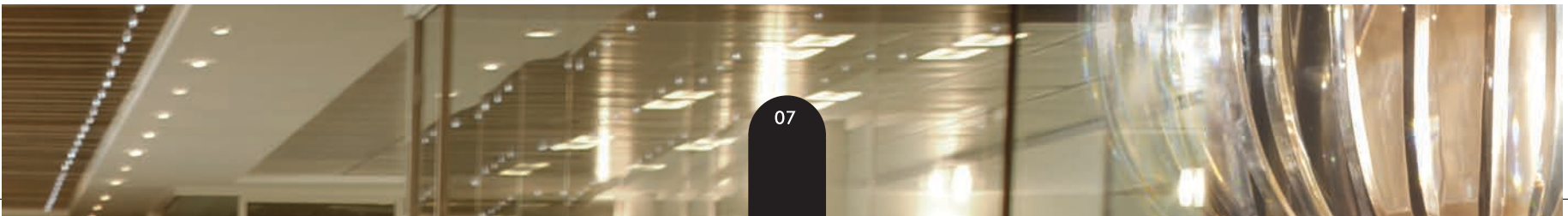
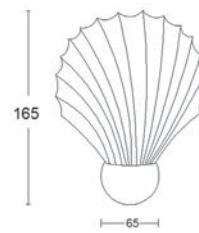

# KRİSTAL SPOTLAR

03.4393

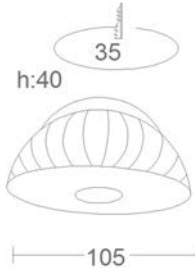

- Krom Kaplamalı Kaide
- Kristal Cam
- Elektronik Trafoya Uygun
- Duy: G4
- Ampül: Halojen Kapsül
- MAX:10-20W
- Kullanım Alanları: Villa, Ev, Ofis, Mağaza, Showroom, Galeri.



03.4385



03.4386

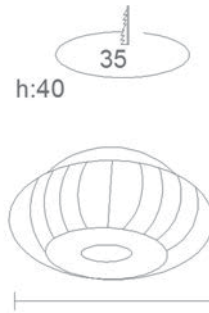

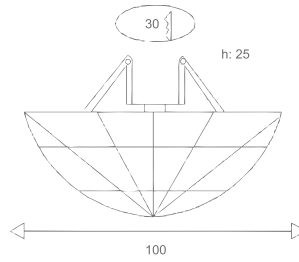

03.4380



03.4379

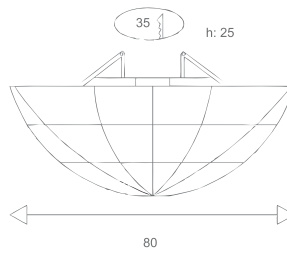

03.4394

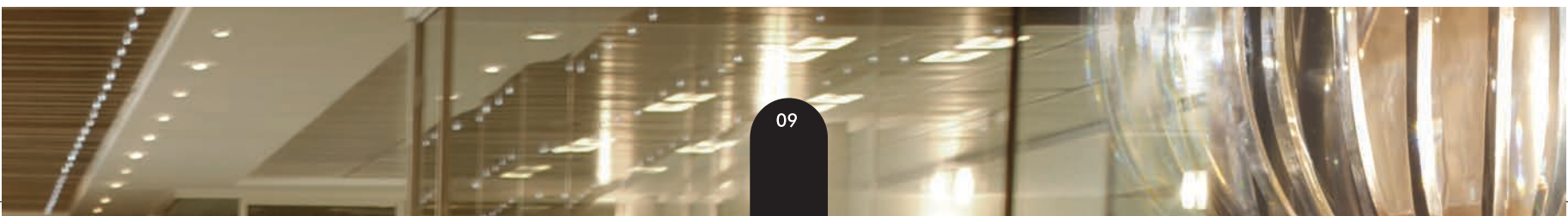
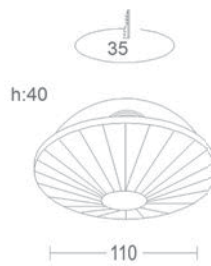

# KRİSTAL SPOTLAR

03.4381

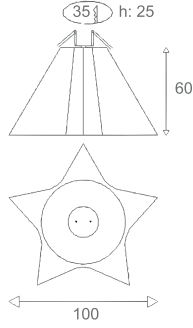

03.4377

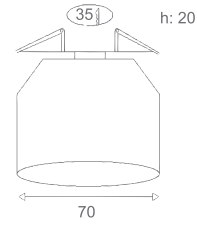

03.4375

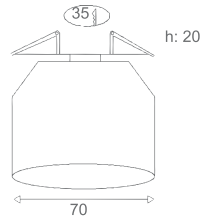

03.4383

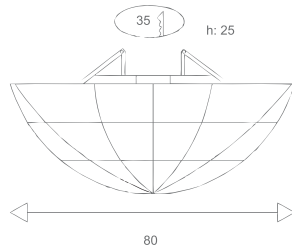

- Krom Kaplamalı Kaide
- Kristal Cam
- Elektronik Trafoya Uygun
- Duy: G4
- Ampül: Halojen Kapsül
- MAX:10-20W
- Kullanım Alanları: Villa, Ev, Ofis, Mağaza, Showroom, Galeri.





03.4392



03.4372

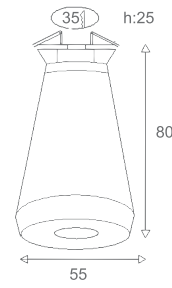

03.4370

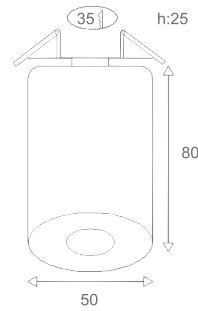

03.4382

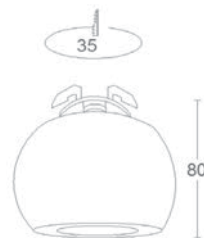

# KRISTAL SPOTLAR

03.4390

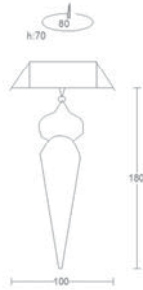

03.4391

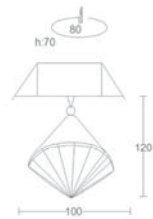

03.4389

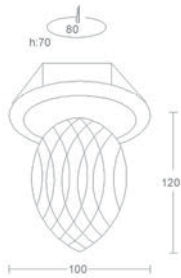

03.4388

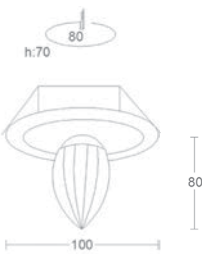

03.4359

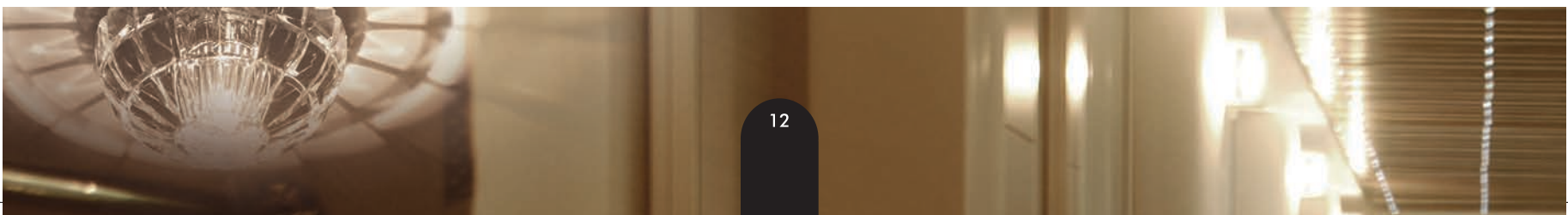
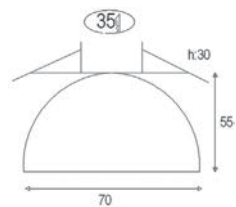



- Krom Kaplamalı Kaide
- Kristal Cam
- Elektronik Trafoya Uygun
- Duy: G4
- Ampül: Halojen Kapsül
- MAX: 10-20W
- Kullanım Alanları: Villa, Ev, Ofis, Mağaza, Showroom, Galeri.

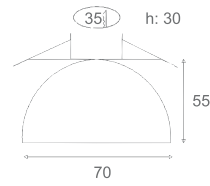
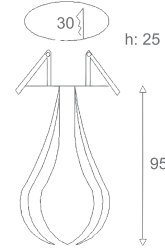
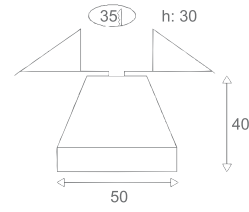
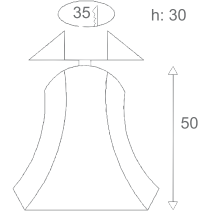
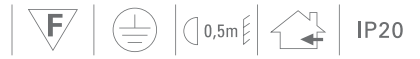

03.4363

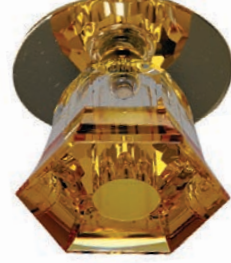

03.4361

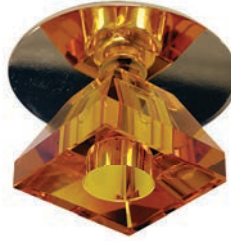

03.4378



03.4358





S T U D I O  
*B*ESTAR  
L I G H T I N G

*BESTAR*.com.tr

## HALOJEN CAM SPOTLAR

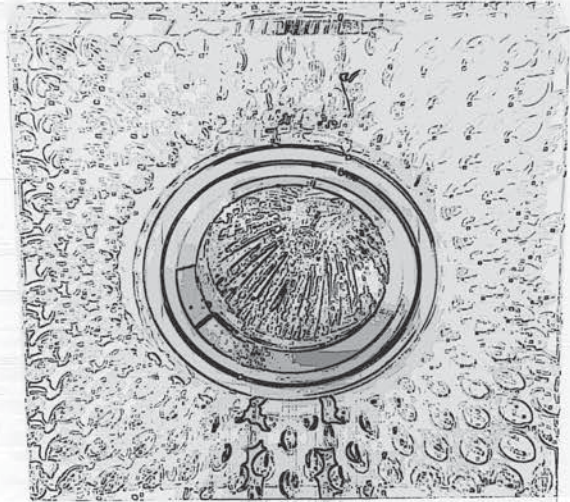
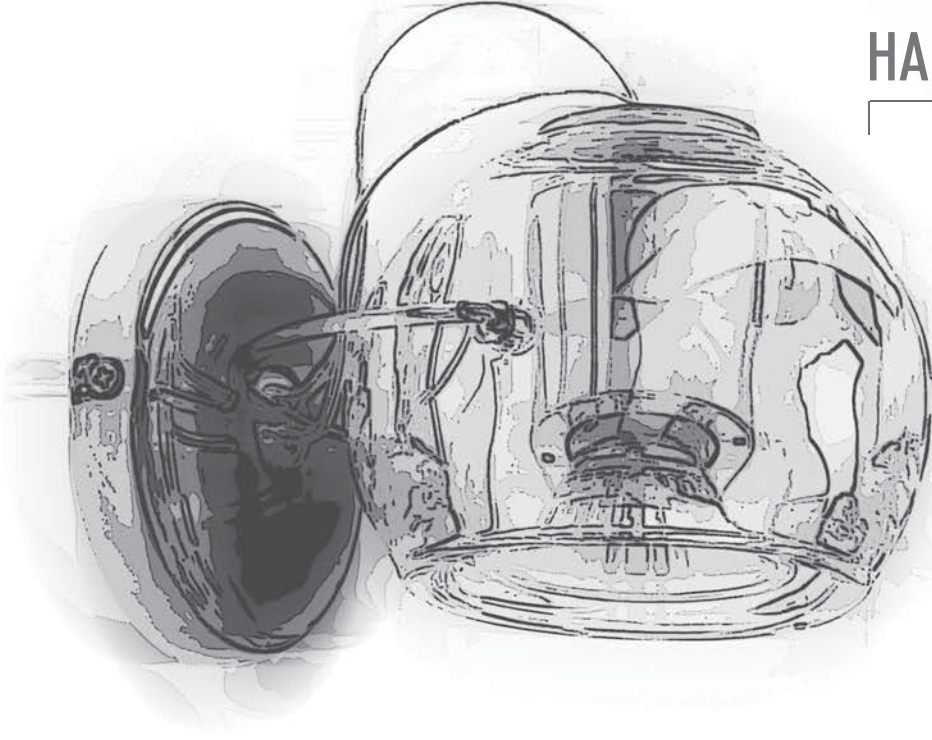

# HALOJEN CAM SPOTLAR

03.4720



03.4720E

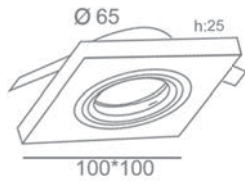

Işıldayan Cam Dünyası

03.4721

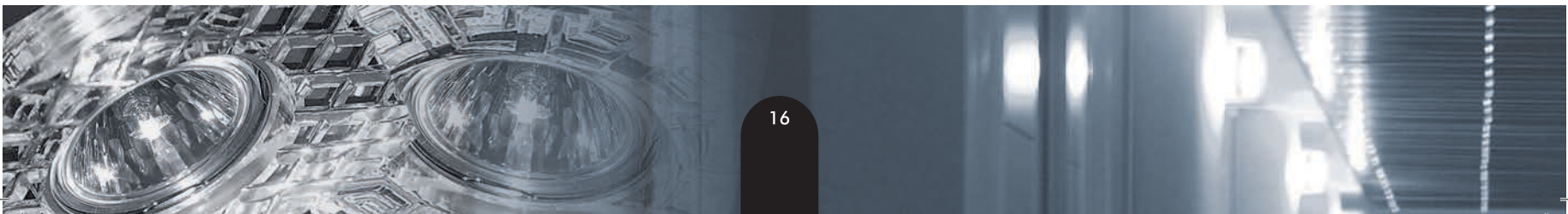
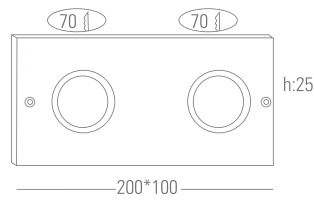

03.4235



CORIAN

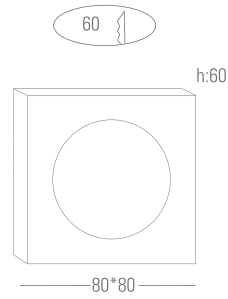

03.4236



03.4238

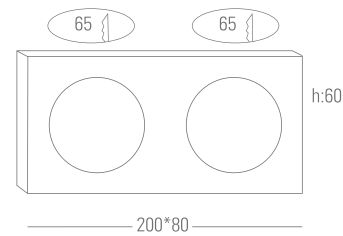

- Alüminyum Kaide
- Şeffaf Cam
- Elektronik Trafoya Uygun
- Duy: GU10/5.3
- MAX: 20-35-50W
- Kullanım Alanları:  
Ev, Ofis, Villa,  
Özel Alanlar

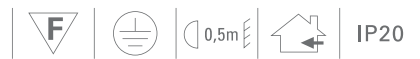

# HALOJEN CAM SPOTLAR

03.4006

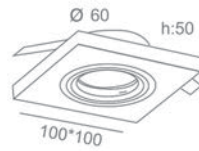

03.4015

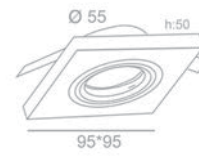

03.4016

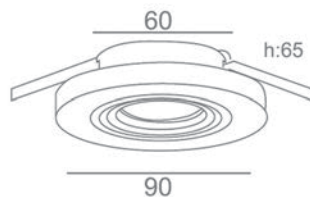

03.4010

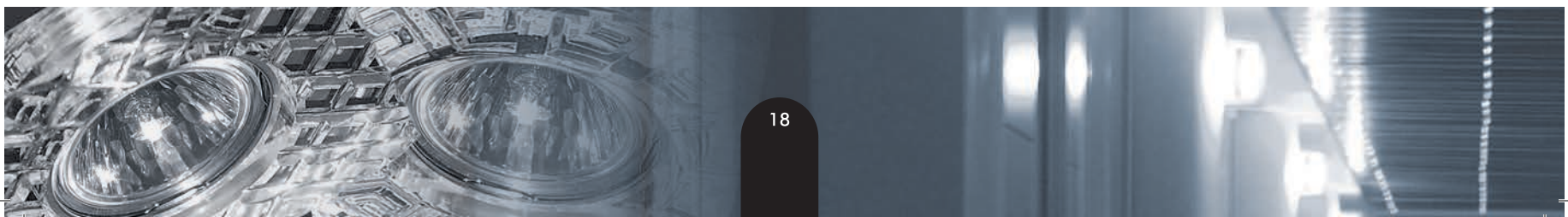
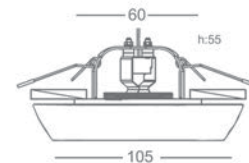

03.4231

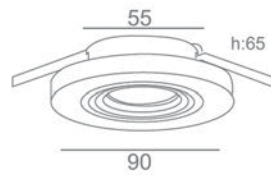

03.4232

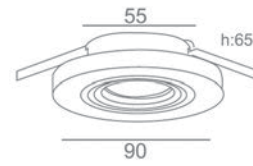

03.4251



- Alüminyum Kaide
- Şeffaf Dekoratif Cam
- Elektronik Trafoya Uygun
- Duy: GU10/5.3
- MAX: 20-35-50W
- Kullanım Alanları:  
Ev, Ofis, Villa,  
Özel Alanlar



03.4252

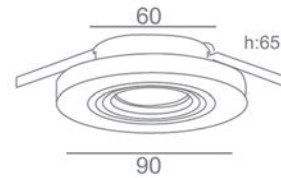

# HALOJEN CAM SPOTLAR

03.4760

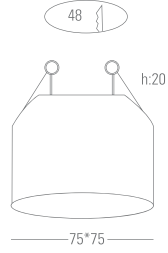

03.4020

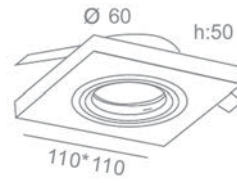

03.4766



03.4762

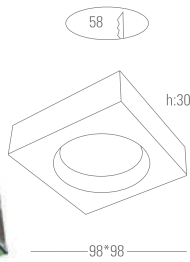
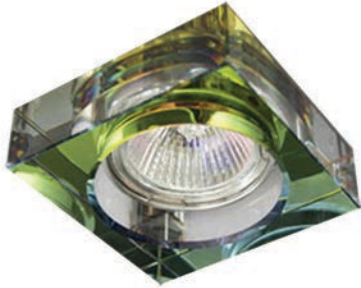

- Alüminyum Kaide
- Şeffaf-Dekoratif Cam
- Elektronik Trafoya Uygun
- Duy: G4/GU10/5.3
- MAX: 20-35-50W
- Kullanım Alanları:  
Ev, Ofis, Villa,  
Özel Alanlar



03.4009

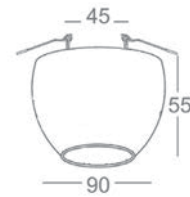

03.4222

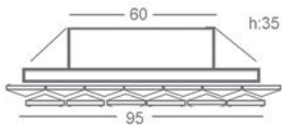

03.4220

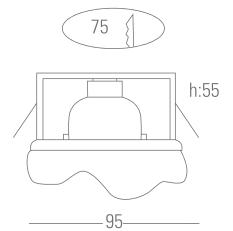

# HALOJEN CAM SPOTLAR

03.4712

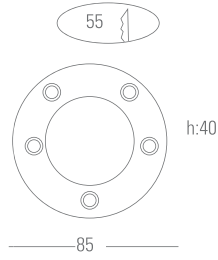

03.4257

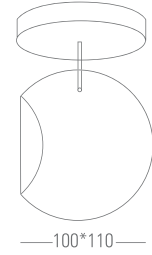

03.4715

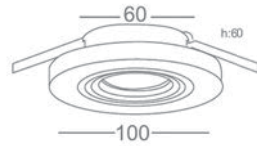

03.4716

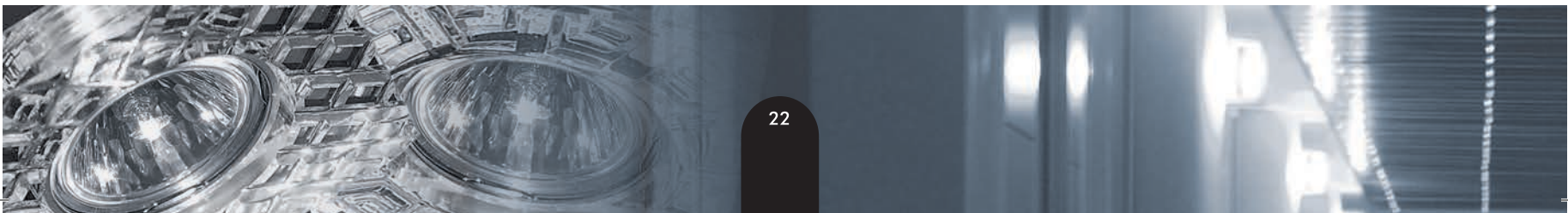
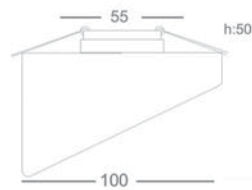



03.4717

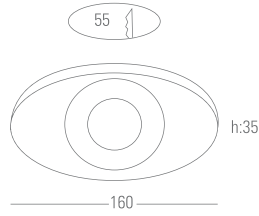

03.4240

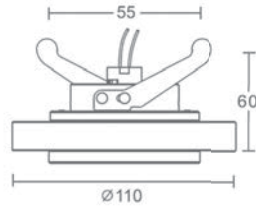

- Alüminyum Kaide
- Şeffaf Cam
- Elektronik Trafoya Uygun
- Duy: GU10/5.3
- MAX: 20-35-50W
- Kullanım Alanları:  
Ev, Ofis, Villa,  
Özel Alanlar



03.6021

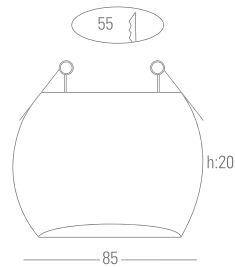

# HALOJEN CAM SPOTLAR

03.4364A

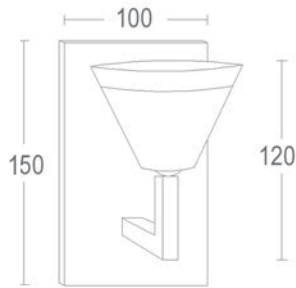

03.4364

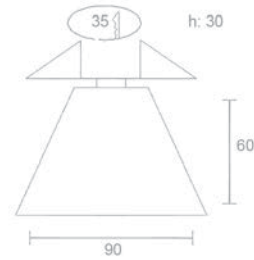

03.4224

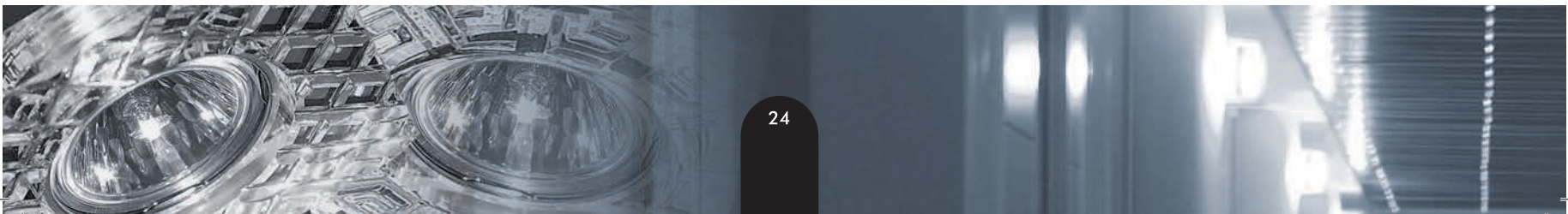
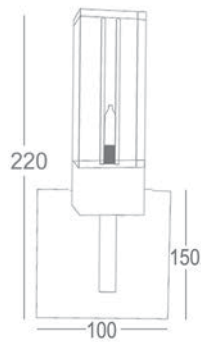

03.4764

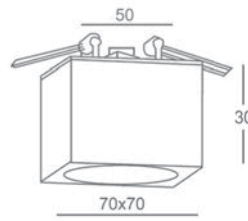

03.4725

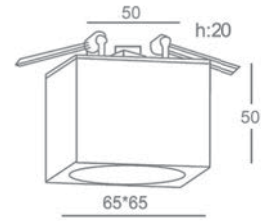

03.4037

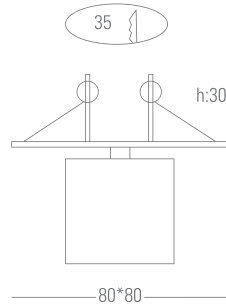

03.4726



- Alüminyum Kaide
- Şeffaf-Dekoratif Cam
- Elektronik Trafoya Uygun
- Duy: G4
- MAX: 10-20W
- Kullanım Alanları:  
Ev, Ofis, Villa,  
Özel Alanlar





 IP20

# HALOJEN CAM SPOTLAR

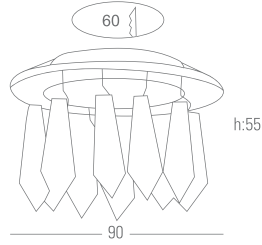
03.6025G



03.6025



03.0163

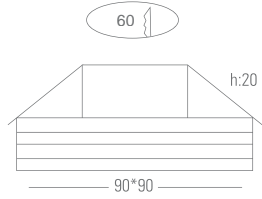

03.0161

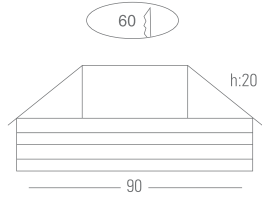

- Alüminyum Kaide
- Şeffaf-Dekoratif Cam
- Elektronik Trafoya Uygun
- Duy: GU10/5.3
- MAX: 20-35-50W
- Kullanım Alanları:  
Ev, Ofis, Villa,  
Özel Alanlar

| F | | | 0,5m | | IP20 |

03.4723

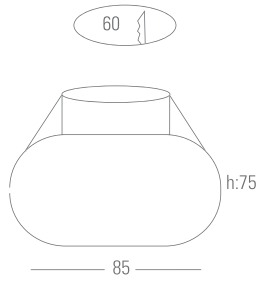

03.4763



03.4767

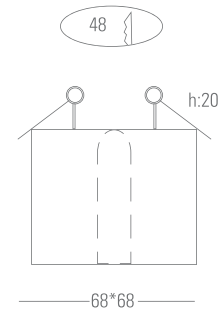



S T U D I O  
*B*ESTAR  
L I G H T I N G

*BESTAR*.com.tr

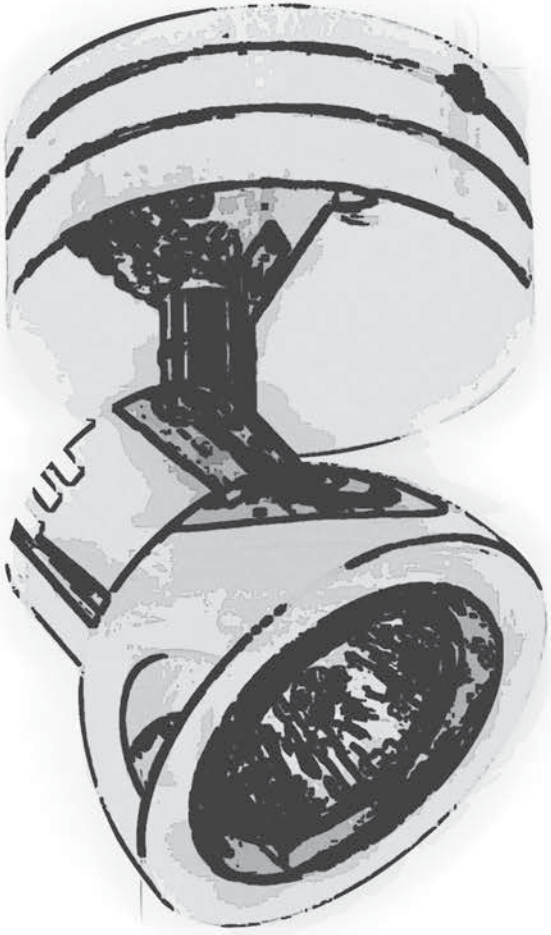

## HALOJEN SPOTLAR



# HALOJEN SPOTLAR

Kromaj Doku

02.4110

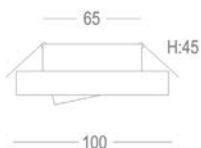

02.4111

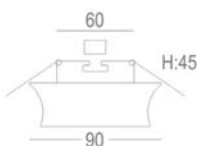

02.4112

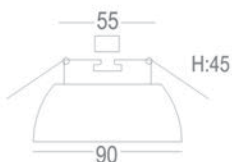

02.4113

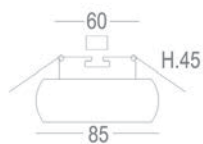

02.4115

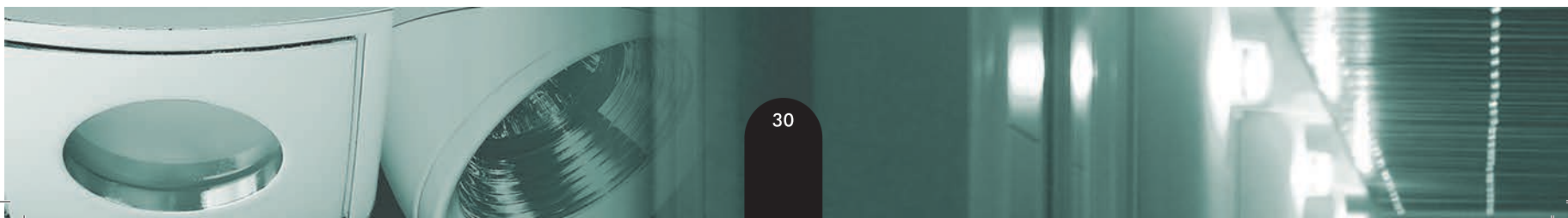
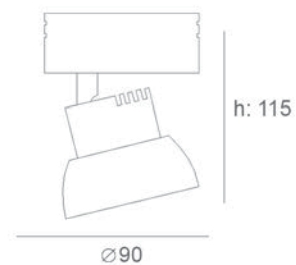



- Alüminyum Gövde
- Özel Krom Kaplama
- Elektronik Trafoya Uygun
- Duy: GU10-G5.3
- Ampül: MR16
- MAX:20-35-50W
- Kullanım Alanları:  
Villalar, Ofisler, Mağazalar,  
Özel Alanlar



02.4116

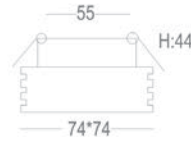

02.4114

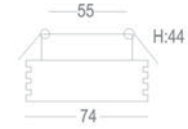

02.4117

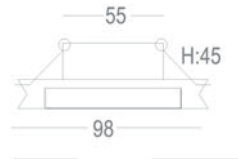

02.4118

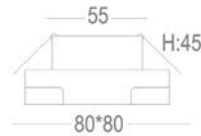
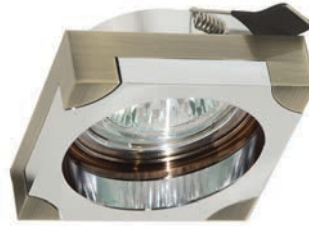

02.4119

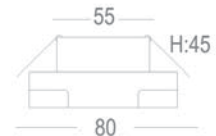

# HALOJEN SPOTLAR

02.4167

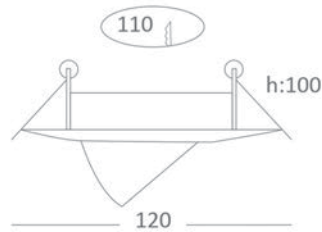

- Alüminyum Gövde
- Adonize Reflektör
- Elektronik Trafoya Uygun
- Duy: G5.3/LED
- Ampül: MR16
- MAX: 20-35-50W
- Kullanım Alanları:  
Villalar, Ofisler, Mağazalar,  
Özel Alanlar

| F | | | 0,5m | | IP20 |

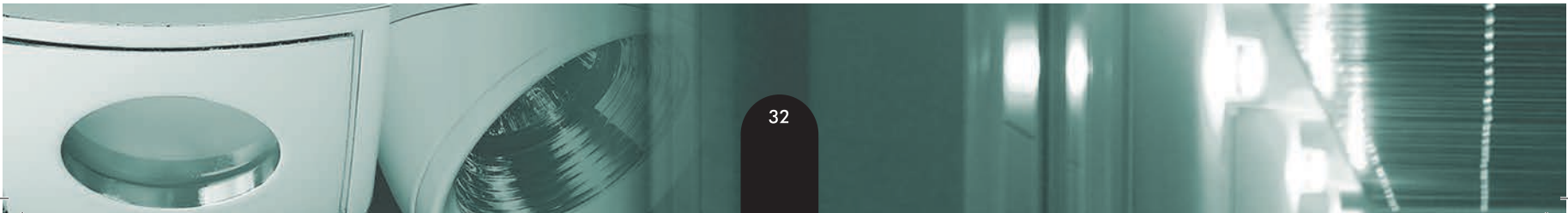



## 02.4565

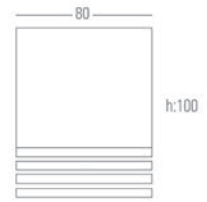

## 02.4060

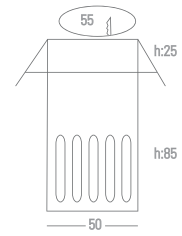

- Alüminyum Gövde
- Duy: G9 / GU10
- Ampül: MR16- GZ9
- MAX:20-35-50W
- Kullanım Alanları:  
Villalar, Ofisler, Mağazalar,  
Özel Alanlar



# HALOJEN SPOTLAR

## DERİN REFLEKTÖR HOMOJENİZE AYDINLATMA

02.4126W

02.4127W

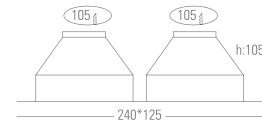
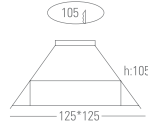

02.4126

02.4127

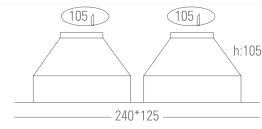
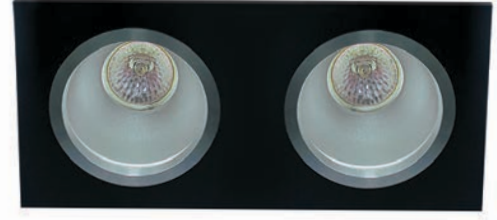
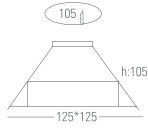

- Alüminyum Gövde
- Adonize Reflektör
- Elektronik Trafoya Uygun
- Duy: G5.3/ GU10
- Ampül: MR16
- MAX: 20-35-50W
- Kullanım Alanları:  
Villalar, Ofisler, Mağazalar,  
Özel Alanlar

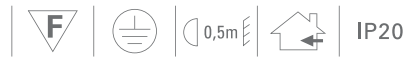

## DARK LIGHT GÖZ KAMAŞMASINA KARŞI

02.4130

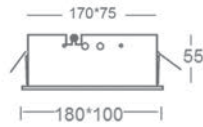

02.4129

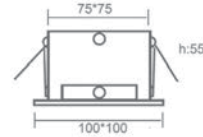

02.4053

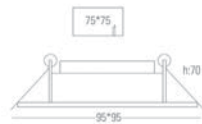

# HALOJEN SPOTLAR

02.4120



02.4121



02.4122

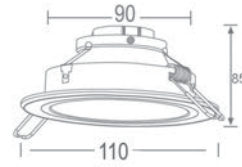

02.4123



- Alüminyum Hareketli Gövde
- Satin Krom Kaplama
- Özel Derin Reflektör
- Elektronik Trafoya Uygun
- Duy: G5.3 / GU10
- Ampül: MR16
- MAX: 20-35-50W
- Kullanım Alanları:  
Villa, Ofis, Mağaza



02.4124



02.4125

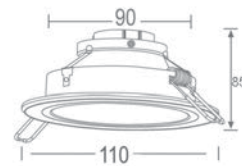

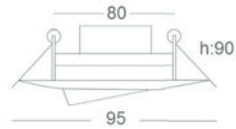

02.4103



02.4104



02.4137



02.4138



02.4108



02.4105

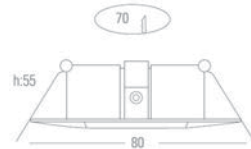

# HALOJEN SPOTLAR

02.4100

MR11

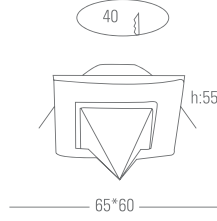

02.4101

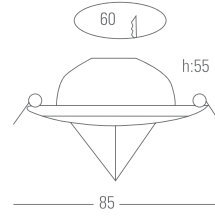

02.4156

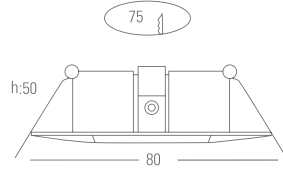

02.4132



02.4054

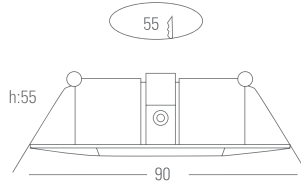

02.4155



- Alüminyum Gövde
- Özel Krom Kaplama
- Elektronik Trafoya Uygun
- Duy: G5.3 / GU10
- Ampül: MR16
- MAX: 20-35-50W
- Kullanım Alanları:  
Villalar, Ofisler, Mağazalar,  
Özel Alanlar



IP44

BANYO SPOT

03

02.4176

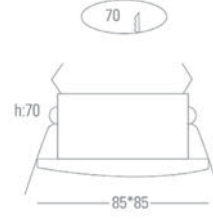

02.4175



02.4173

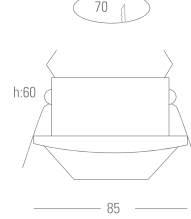
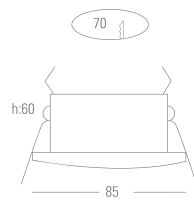

02.4174



02.1094

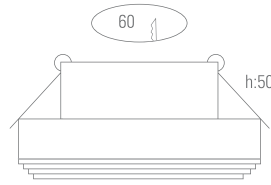

- Alüminyum Gövde
- Cam Difüzör
- Elektronik Trafoya Uygun
- Duy: G5.3 / GU10
- Ampül: MR16
- MAX: 20-35-50W
- Kullanım Alanları:  
Mutfak, Banyo, Nemli Ortamlar

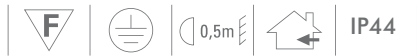

BESTAR.com.tr

# HALOJEN SPOTLAR

02.1091

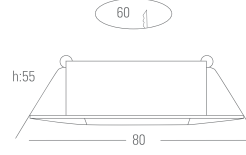

02.1150

MR11



02.1151

MR11

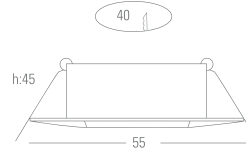

02.1162



02.1160

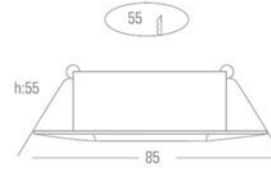

- Alüminyum Gövde
- Elektronik Trafoya Uygun
- Duy: G5.3
- Ampül: MR16-MR11
- MAX: 20-35-50W
- Kullanım Alanları:
- Evi Ofis, Mağaza, Özel Alanlar



## MOB SPOT

02.4086

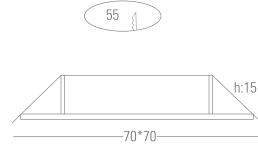
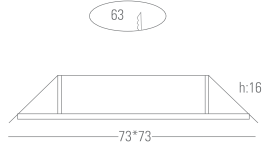

02.5361



02.4091

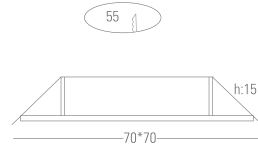
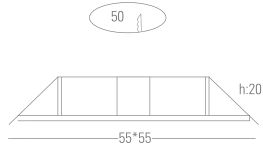

02.5360



02.5381

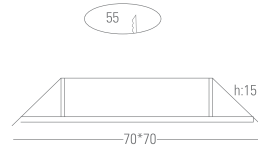
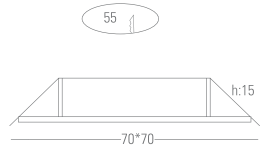

02.1177



- Mob Spot (Mobilya)
- Zamak Gövde
- Elektronik Trafoya Uygun
- Duy: G4
- Ampül: Kapsül
- MAX: 10-20W
- Kullanım Alanları:  
Dolap İçi, Ahşap Tezgah Altı



02.1172

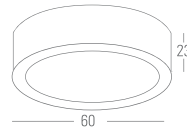

# HALOJEN SPOTLAR

02.4631

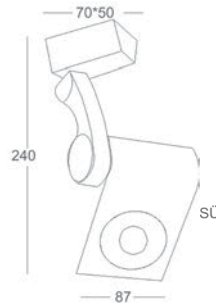

02.0165

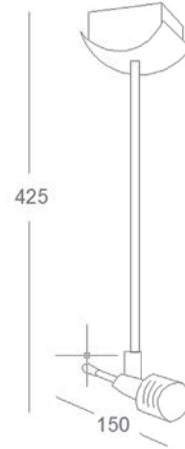

02.4632

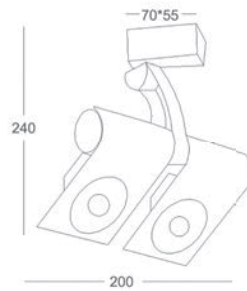
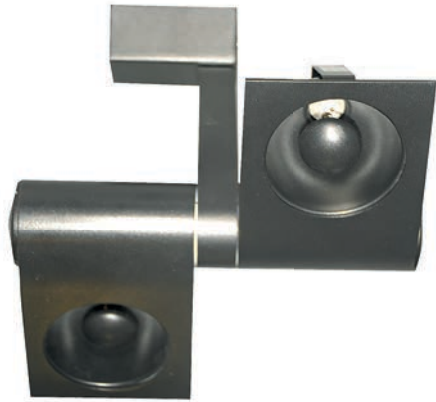

- Hareketli Aplik
- Spiral
- Elektronik Trafoya Uygun
- Duy: G4
- Ampül: Kapsül
- MAX: 10-20W
- Kullanım Alanları:  
Ev, Ofis, Mağaza,

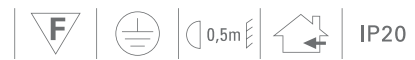

02.5365



02.5366







02.5370



02.5377



- Hareketli Aplik
- Spiral
- Elektronik Trafoya Uygun
- Duy: G4
- Ampül: Kapsül
- MAX: 10-20W
- Kullanım Alanları:  
Ev, Ofis, Mağaza,

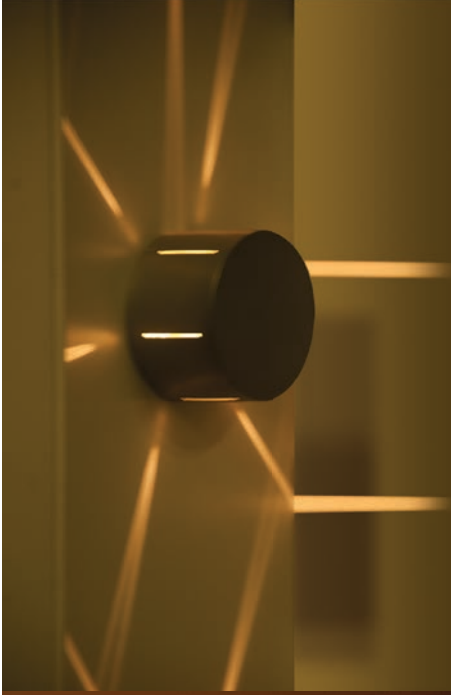

 0,5m
  IP20

# HALOJEN SPOTLAR

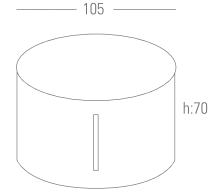

02.4340



02.4346

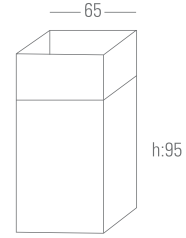

- Alüminyum Gövde
- Efektif Difüzör
- Elektronik Trafoya Uygun
- Duy: GZ9
- Ampül: HALojen
- MAX: 20-40W
- Kullanım Alanları:  
Ev, Ofis, Mağaza,

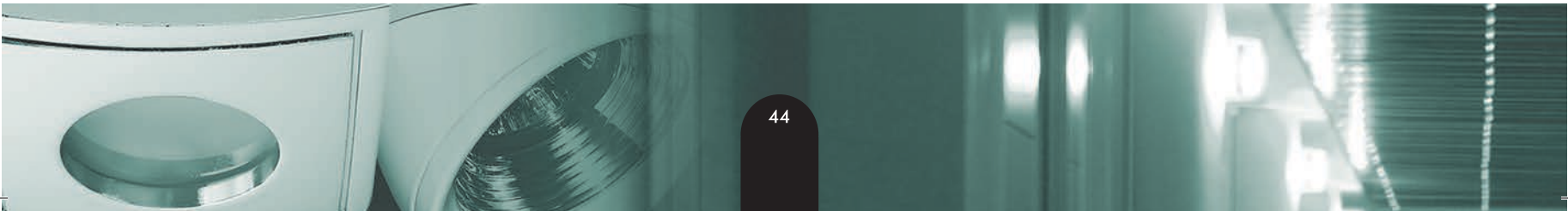
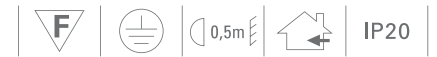

02.4063SG



02.4063B

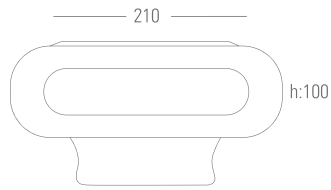

02.4064G

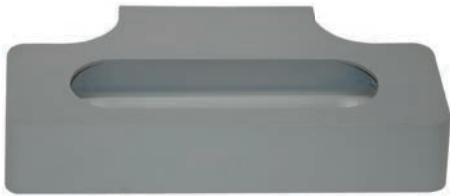

02.4064B



02.4067



- Alüminyum Enjeksiyon Gövde
- Cam Difüzör
- Endirekt
- Duy: R7s
- Ampül: Halojen
- MAX:100W
- Kullanım Alanları:  
Ev, Ofis, Mağaza,

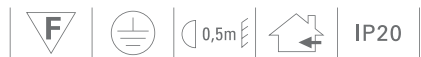



STUDIO  
*B*ESTAR  
LIGHTING

BESTAR.com.tr

## PROFESYONEL AYDINLATMALAR

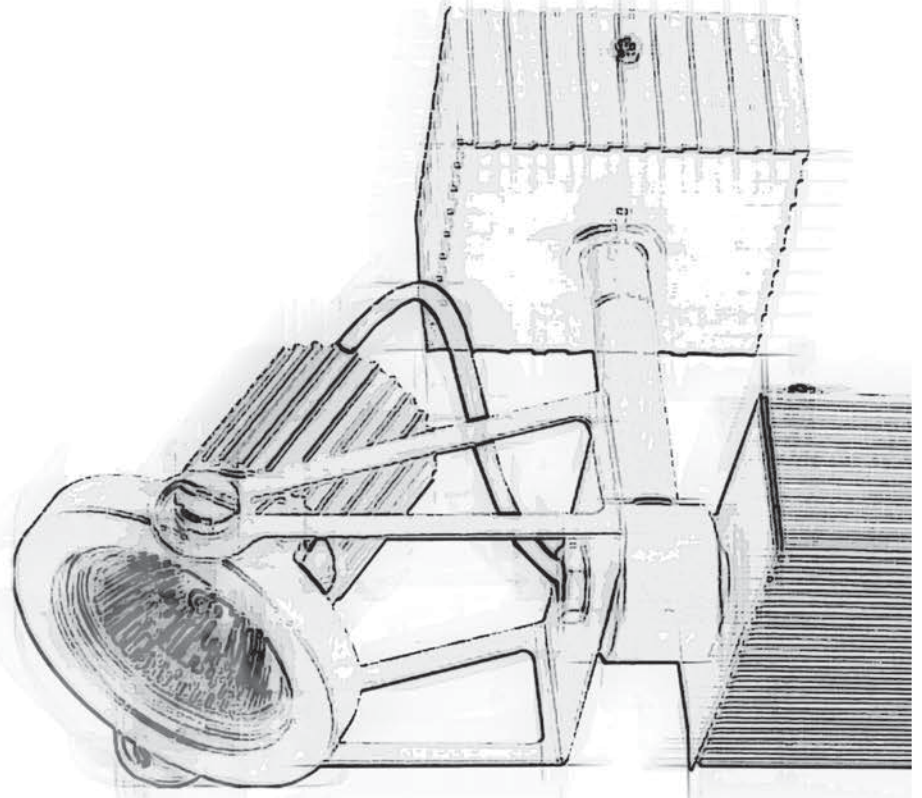
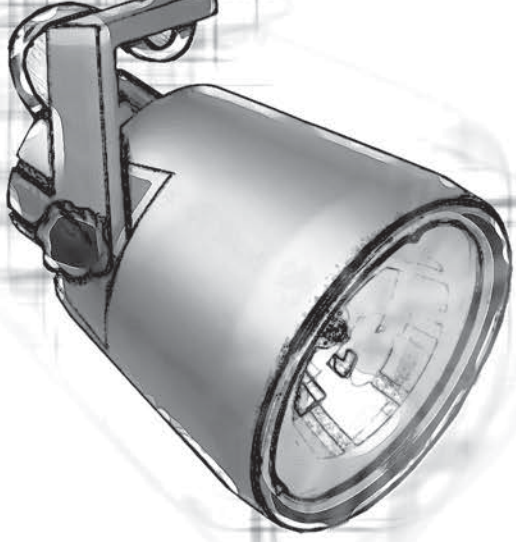

# PROFESYONEL AYDINLATMALAR

Seçkinlerin Tercihi

06.4519

06.4509

CDM-R111

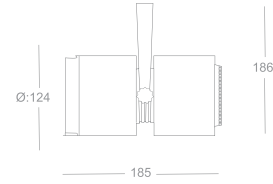
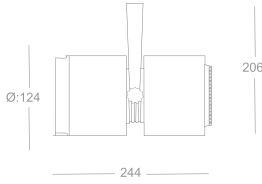

- Alüminyum Hareketli Gövde
- Trifaze Ray Soketi
- Elektronik Balasta Uygun
- Duy: G12 / G8.5
- Ampül: CDM-T / CDM-R111
- MAX: 35-70W
- Kullanım Alanları:  
Mağaza, Showroom, Galeri,  
Özel Alanlar

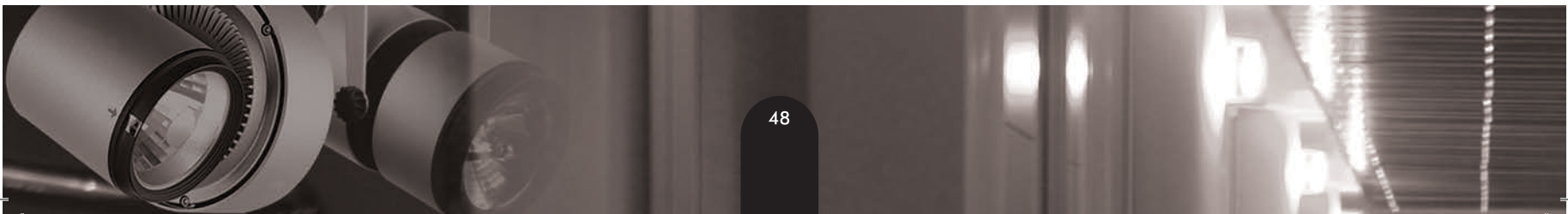

06.4509

06.4517

QR111

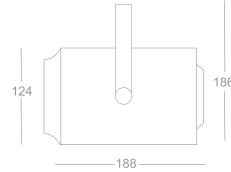
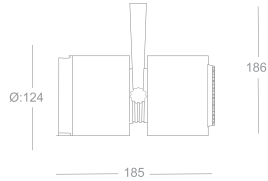

- Alüminyum Hareketli Gövde
- Trifaze Ray Soketi
- Elektronik Balasta Uygun
- Duy: E27 / G5.3
- Ampül: PAR30 / QR111
- MAX: 50-75-100W
- Kullanım Alanları:  
Mağaza, Showroom, Galeri,  
Özel Alanlar



# PROFESYONEL AYDINLATMALAR

06.4471

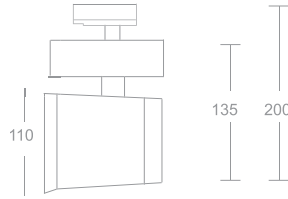

06.4444

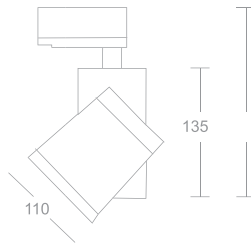

- Alüminyum Hareketli Gövde
- Trifaze Ray Soketi
- Elektronik Balasta Uygun
- Duy: G12 / G8.5
- Ampül: CDM-T / CDM-TC
- MAX: 35-70W
- Kullanım Alanları:  
Mağaza, Showroom, Galeri,  
Özel Alanlar

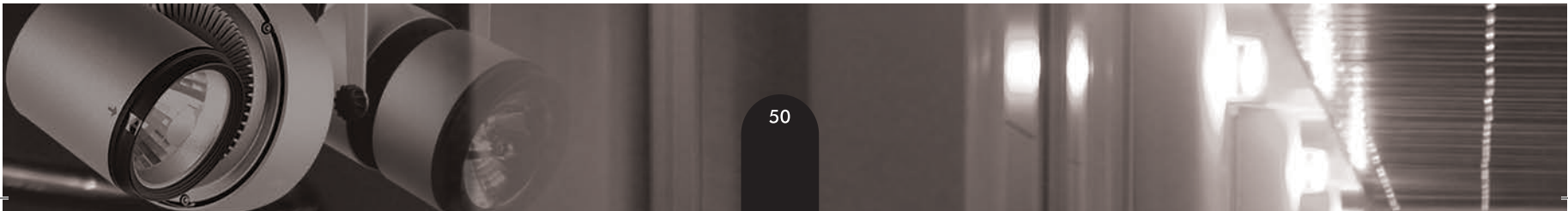

06.4460

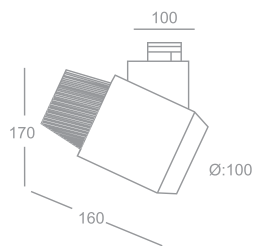

06.4447

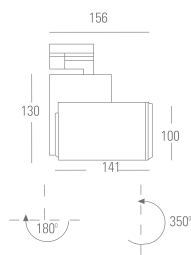

# PROFESYONEL AYDINLATMALAR



- Alüminyum Hareketli Gövde
- Trifaze Ray Soketi
- Elektronik Balasta Uygun
- Duy: G12 / G8.5 / PGj5
- Ampül: CDM-T / CDM-TC
- MAX:20-35-70W
- Kullanım Alanları:  
Mağaza, Showroom, Galeri,  
Özel Alanlar

| F | | 0,5m | | IP20 |

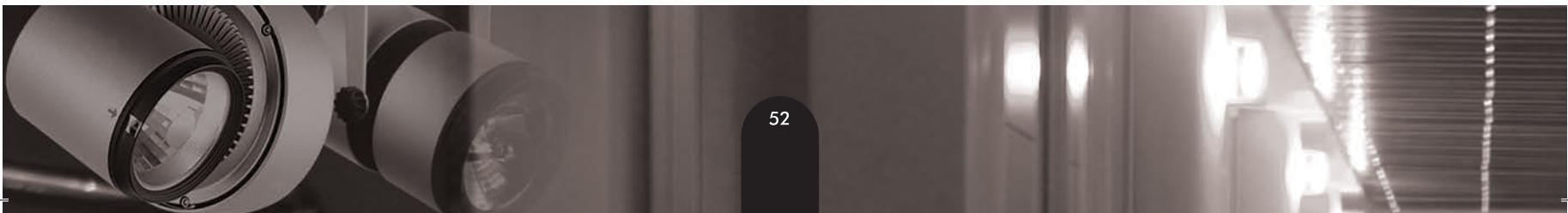

## 06.4440



## 06.4440B

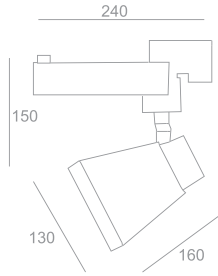

## 06.4440W



- Alüminyum Hareketli Gövde
- Trifaze Ray Soketi
- Elektronik Balasta Uygun
- Duy: G12 / G8.5 / PGj5
- Ampül: CDM-T / CDM-TC
- MAX:20-35-70W
- Kullanım Alanları:  
Mağaza, Showroom, Galeri,  
Özel Alanlar

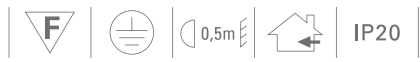

06.4752

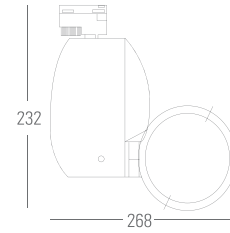

- Alüminyum Hareketli Gövde
- Trifaze Ray Soketi
- Elektronik Balasta Uygun
- Duy: G12 / G8.5 / PGi5
- Ampül: CDM-T / CDM-TC
- MAX:20-35-70W
- Kullanım Alanları:  
Mağaza, Showroom, Galeri,  
Özel Alanlar

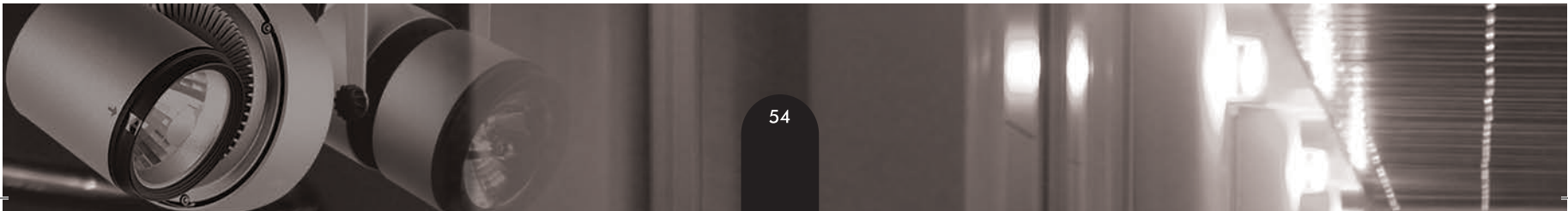

06.4513

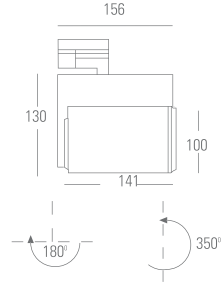

06.4453

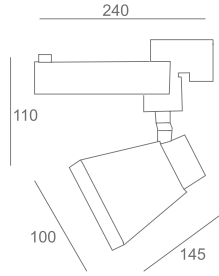

06.4443

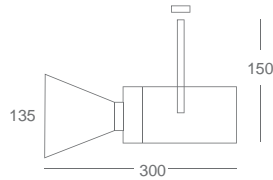

- Alüminyum Hareketli Gövde
- Trifaze Ray Soketi
- Elektronik Balasta Uygun
- Duy: G12 / G8.5 / PGi5
- Ampül: CDM-T / CDM-TC
- MAX:20-35-70W
- Kullanım Alanları:  
Mağaza, Showroom, Galeri,  
Özel Alanlar

| F | | 0,5m | | IP20 |

BESTAR.com.tr

# PROFESYONEL AYDINLATMALAR

---

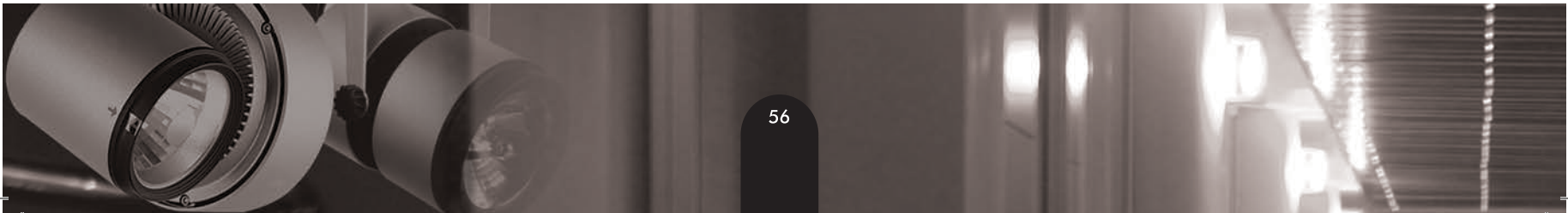

06.4452

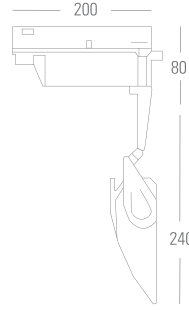



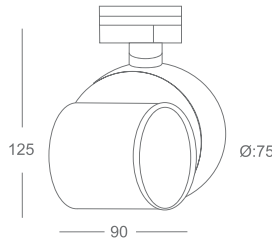

06.4466



06.4520

- Alüminyum Hareketli Gövde
- Trifaze Ray Soketi
- Elektronik Balasta Uygun
- Duy: Rx7s / PGj5 / E27
- Ampül: CDM-TD / CDM-TM / CDM-PAR
- MAX: 20-35-70W
- Kullanım Alanları:  
Mağaza, Showroom, Galeri,  
Özel Alanlar

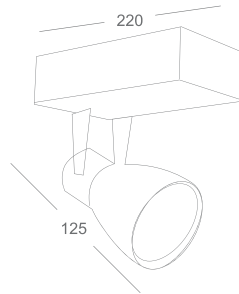

 0,5m
  IP20



BESTAR.com.tr

# PROFESYONEL AYDINLATMALAR

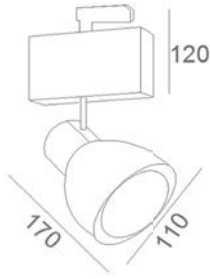
06.7009



06.4518

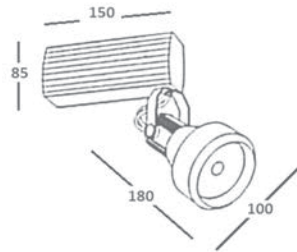

- Alüminyum Hareketli Gövde
- Trifaze Ray Soketi
- Elektronik Balasta Uygun
- Duy: G12 / Rx7s
- Ampül: CDM-T / CDM-TD
- MAX: 35-70W
- Kullanım Alanları:  
Mağaza, Showroom, Galeri,  
Özel Alanlar

| F | ⚡ | 0,5m | 🏠 | IP20 |

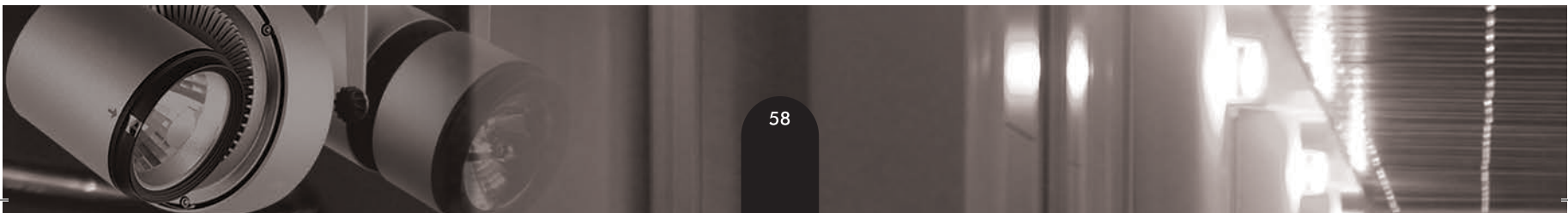

06.2170

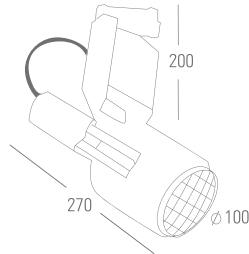

06.7007

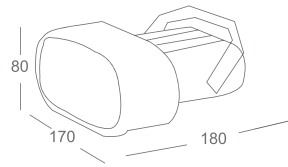

06.7007B

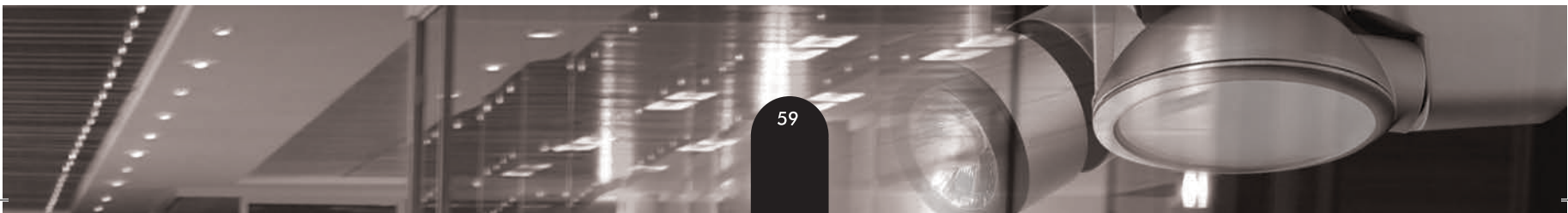

# PROFESYONEL AYDINLATMALAR

06.4248

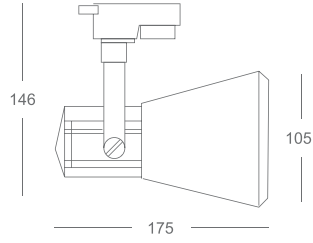

06.4248G



06.4614B

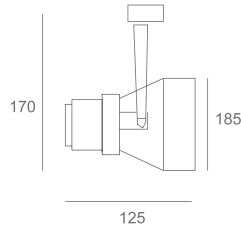

06.4614W

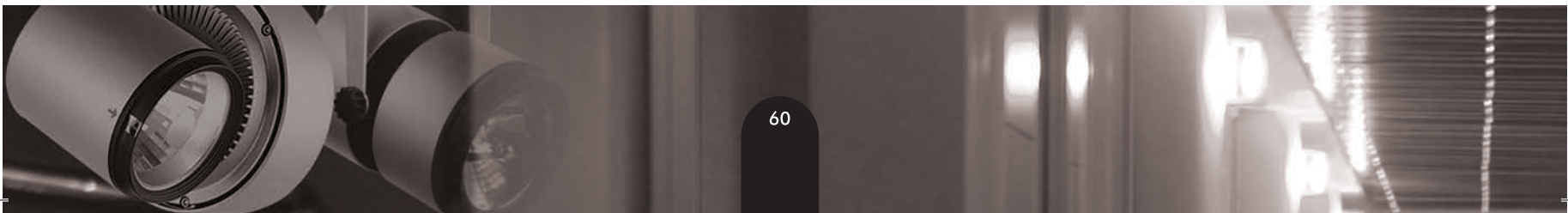

06.4615G



06.4615W

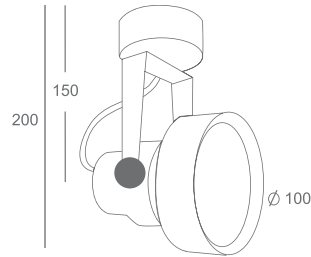

- Alüminyum Hareketli Gövde
- Trifaze Ray Soketi
- Elektronik Balasta Uygun
- Duy: G4 / E27 / G9
- Ampül: PAR 30 / Kapsül Halojen
- MAX: 20-50-75-100W
- Kullanım Alanları:  
Mağaza, Showroom, Galeri,  
Özel Alanlar

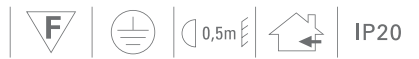

06.2019

06.2018

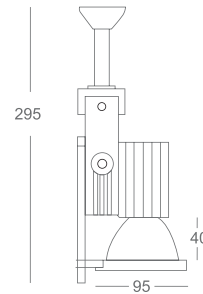

# PROFESYONEL AYDINLATMALAR

06.4245



06.4246

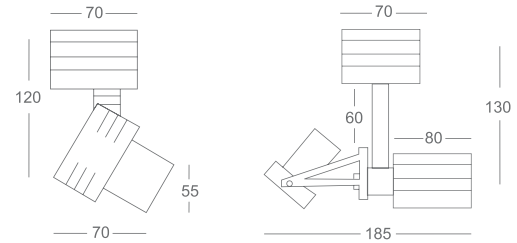

06.4616

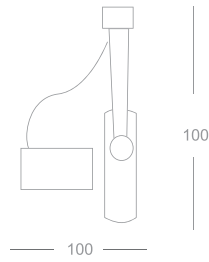

- Alüminyum Hareketli Gövde
- Trifaze Ray Soketi
- Elektronik Balasta Uygun
- Duy: G5.3 / E27 / GU10
- Ampül: Halojen
- MAX: 20-50-75-100W
- Kullanım Alanları:  
Mağaza, Showroom, Galeri,  
Özel Alanlar

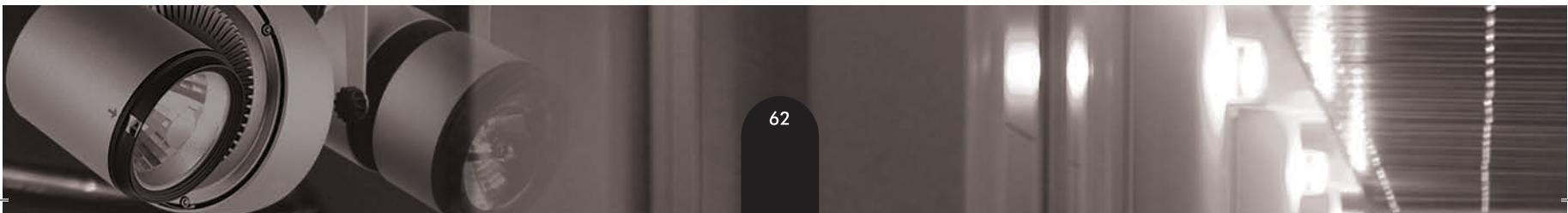

06.4501



06.4500

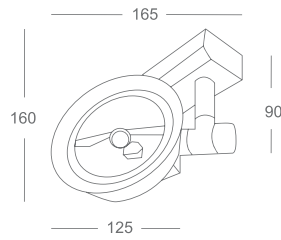

06.4502R



06.4501R

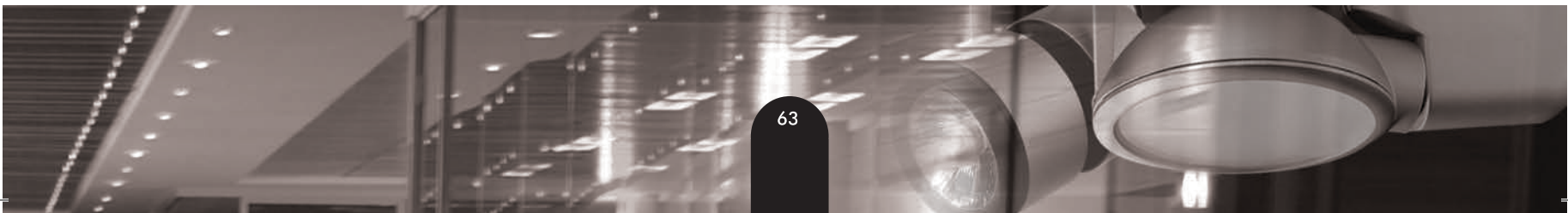
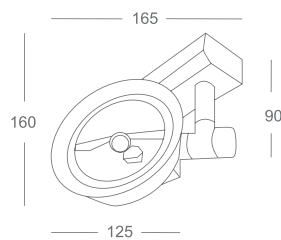

# PROFESYONEL AYDINLATMALAR

06.4401

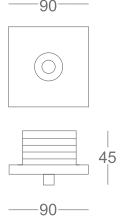

06.4402



06.4413

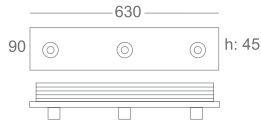

- Alüminyum Gövde
- Hareketli Kafa
- Opsiyonel Ampul Taşıyıcı
- Sıva Üstü
- Elektronik Trafoya uygun
- Duy: G53
- Ampül: QR111 Halojen
- MAX: 50 W
- Kullanım Alanları:  
Mağaza, Showroom, Galeri,  
Özel Alanlar



06.4424

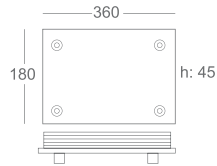

06.4414

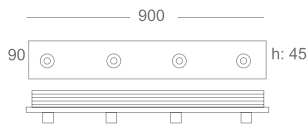

06.4432



06.4431



06.4433

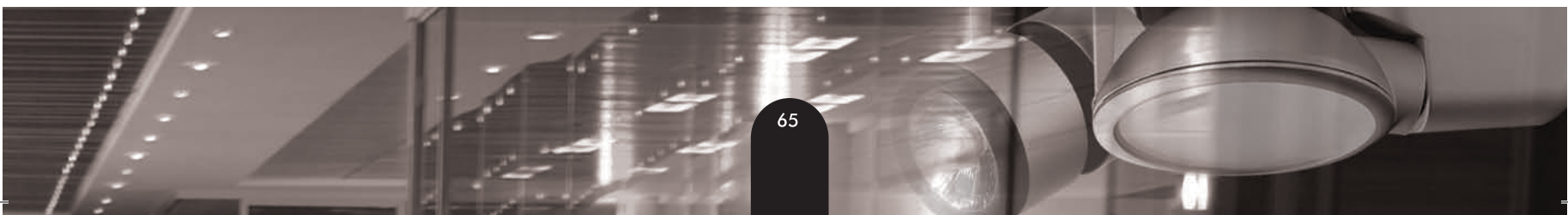
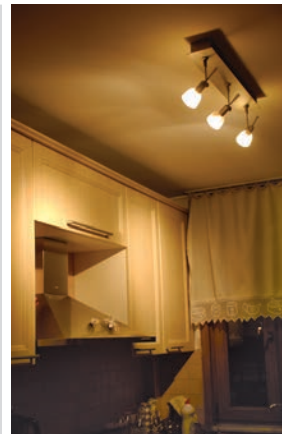
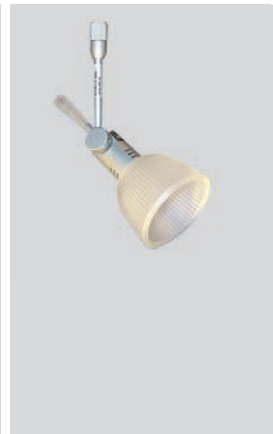
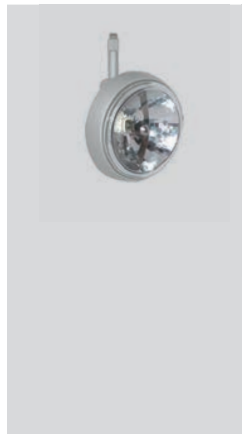

# PROFESYONEL AYDINLATMALAR

06.2021

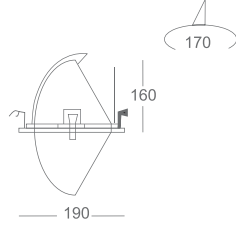

06.2022

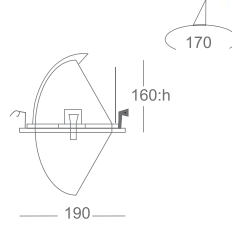

06.2024

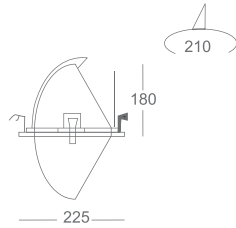

06.2020

Rx7s

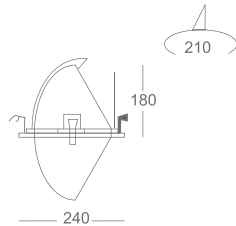

- Alüminyum Enjeksiyon Gövde
- Salyangoz Hareketli
- Adonize Reflektör
- CMD-T G12
- Elektronik Balasta Uygun
- MAX: 35-70-150W
- Kullanım Alanları:  
Mağaza, Showroom, Galeri,  
Özel Alanlar

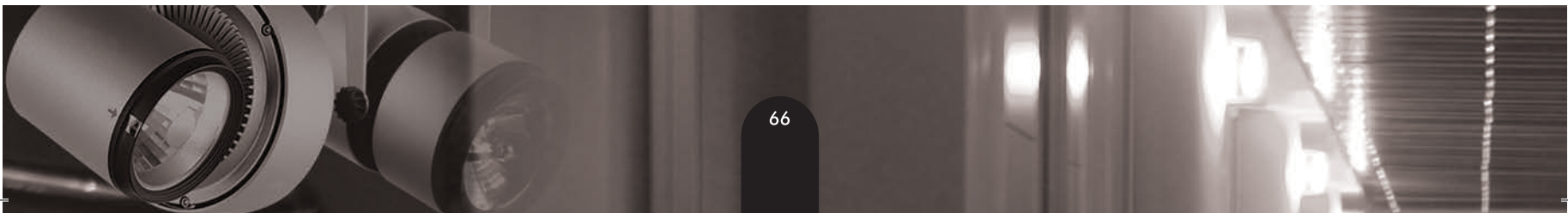

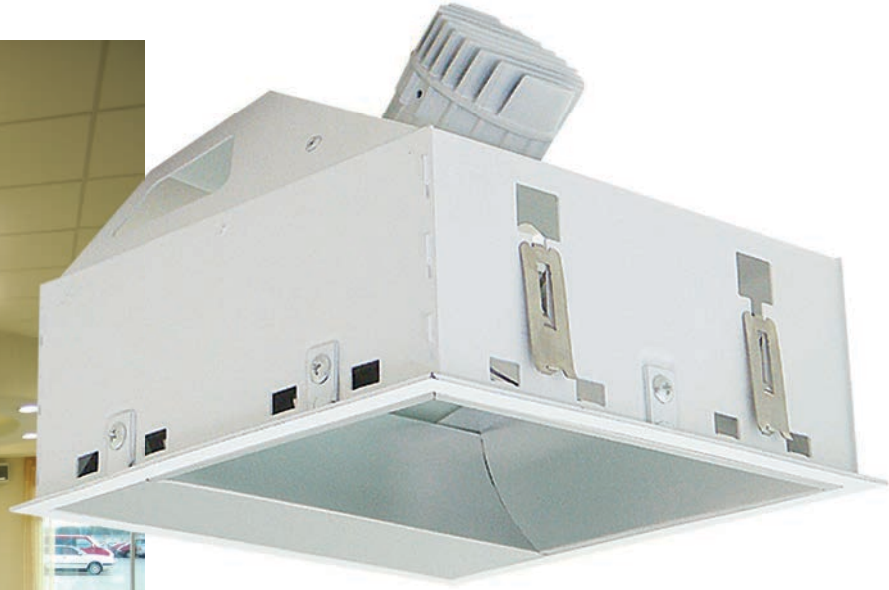



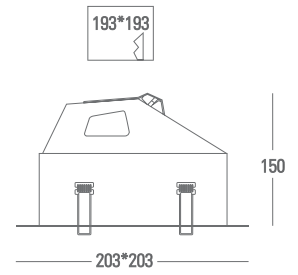

06.2045



- Alüminyum Gövde
- Asimetrik
- Adonize Reflektör
- Elektronik Balasta Uygun
- Duy: G12
- Ampül: CDM-T
- MAX: 35 -70 -150W
- Kullanım Alanları:  
Mağaza, Showroom, Galeri,  
Özel Alanlar



 0,5m
  IP20

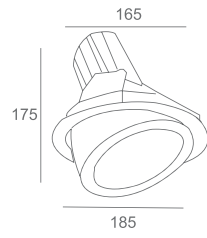

# PROFESYONEL AYDINLATMALAR

06.2012



06.2183

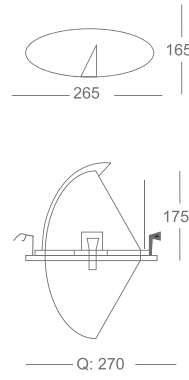

06.4637

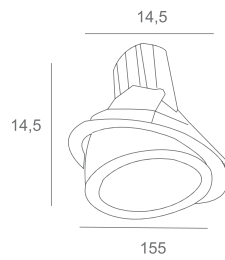

06.4638

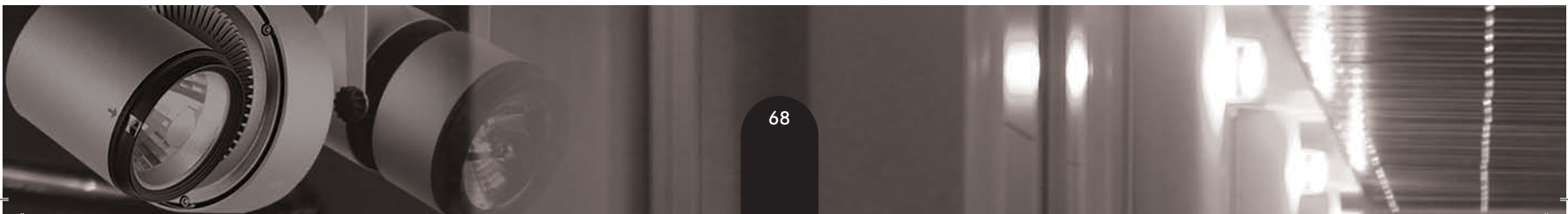

06.4609

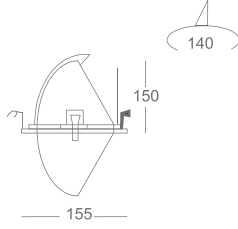

- Alüminyum Enjeksiyon Gövde
- Hareketli
- Elektronik Balasta Uygun
- Duy: G12 / Rx7s / E27
- Ampül: CDM - TC / QR 111
- MAX: 35-70W
- Kullanım Alanları:  
Mağaza, Showroom, Galeri,  
Özel Alanlar

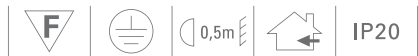

06.4613



06.4530

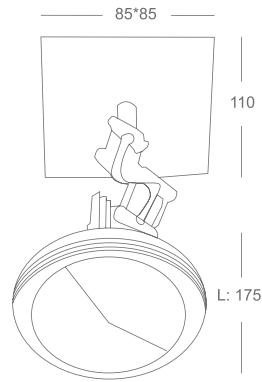

# PROFESYONEL AYDINLATMALAR

06.2053

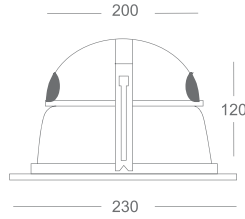

06.2057



**IP55**

06.2027

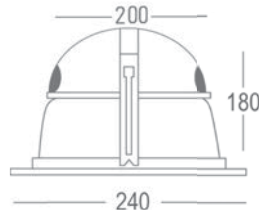

- Alüminyum Enjeksiyon Gövde
- Adonize Reflektör
- Elektronik Balasta Uygun
- Duy: Rx7s / G12
- Ampül: CDM-T / CDM-TM
- MAX: 70-150W
- Kullanım Alanları:  
Yüksek Tavanlı Mağaza, Showroom,  
Galeri, Özel Alanlar

⚡ | ⚙️ | 0,5m | 🏠 | IP55

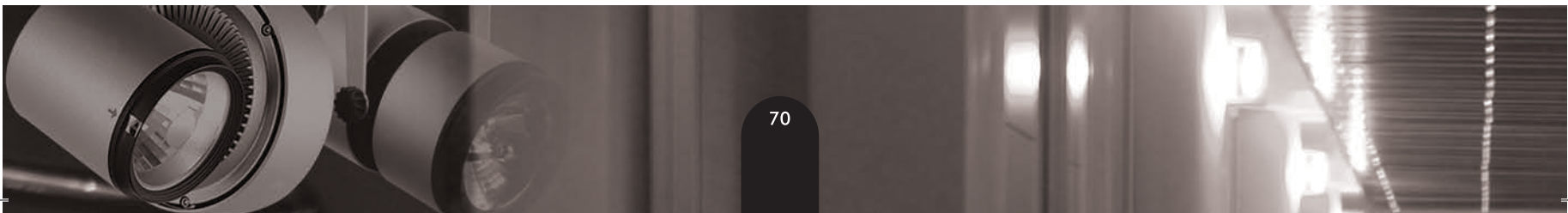

06.4109

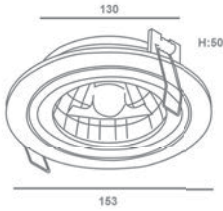

06.4612



06.4611

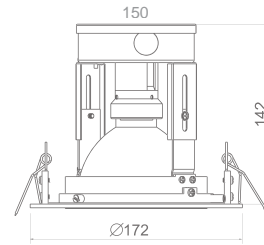

06.4610

QR 111

CDM-R 111

- Alüminyum Enjeksiyon Gövde
- Adonize Reflektör
- Elektronik Balasta Uygun
- Duy: G4 / E27 / G12 / Gx8.5
- Ampül: CDM-T / QR111 / CDM-PAR
- MAX: 20-35-70W
- Kullanım Alanları:  
Yüksek Tavanlı Mağaza, Showroom,  
Galeri, Özel Alanlar

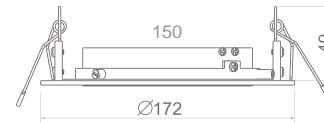
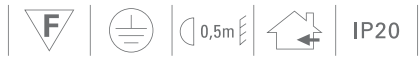

# PROFESYONEL AYDINLATMALAR



Akıllı Kombinasyon  
Kolay Montaj  
Muhteşem Dizayn

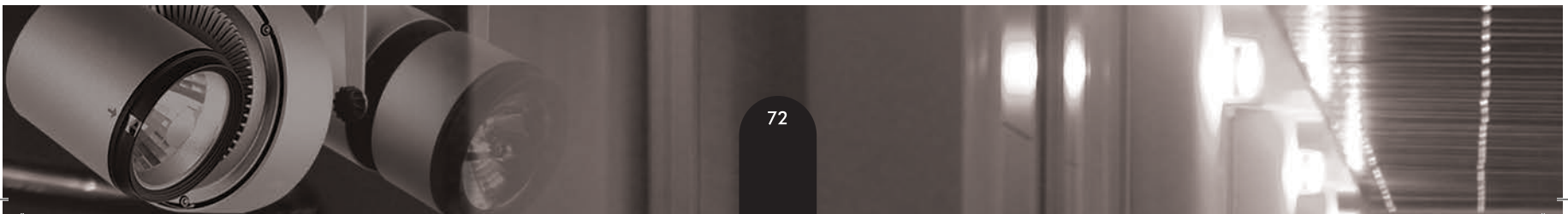

06.4650

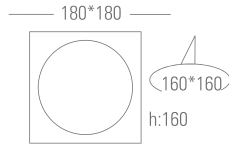

06.4655

CDM-R 111



06.4655

QR 111



06.4656

CDM-R E27



06.4657

CDM-T



- Alüminyum Enjeksiyon Gövde
- Çoklu Ampül Seçeneği
- Elektronik Balasta Uygun
- Duy: E27 / G12 / Gx8.5
- Ampül: CDM-T / QR111 / CDM-PAR / CDM-QR111
- MAX: 20-35-70W
- Kullanım Alanları:  
Yüksek Tavanlı Mağaza, Showroom,  
Galeri, Özel Alanlar



# PROFESYONEL AYDINLATMALAR

Ayrıcalıklı Mekanların  
Muhteşem Kombinasyonu





# PROFESYONEL AYDINLATMALAR

## Doğru Tercihlerin Akıllı Yansıması



- Metal Kasa, Alüminyum Çerçeve
- Hareketli, Çok Yönlü
- Elektronik Balasta Uygun
- Ampül: QR 111
- MAX: 50-75-100W
- Kullanım Alanları:  
Mağaza, Showroom, Galeri,  
Özel Alanlar

| F | | 0,5m | | IP20 |

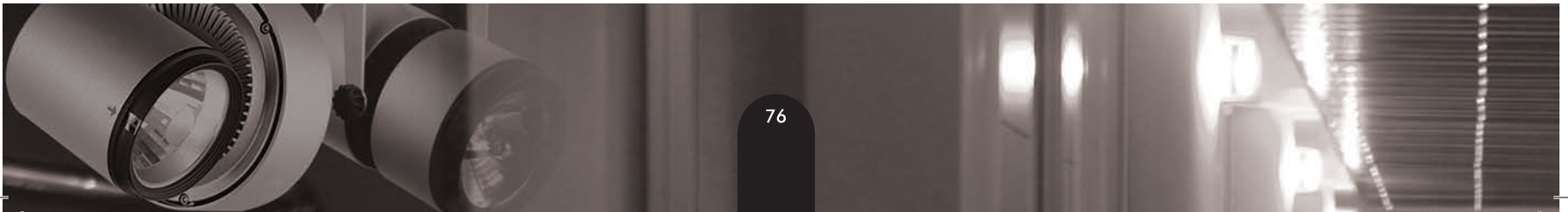



06.4546

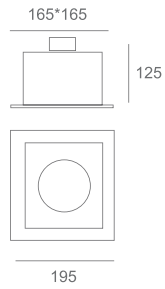

06.4547

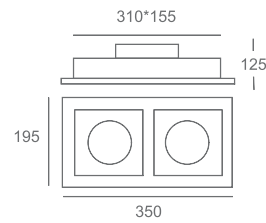

06.4548

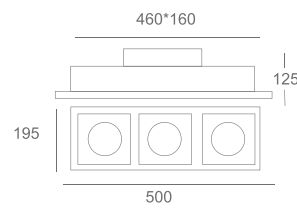

# PROFESYONEL AYDINLATMALAR

06.4603



06.4531 QR-111  
06.4531 CDM-R 111  
06.4526 CDM-R PAR  
06.4521 CDM-T G12

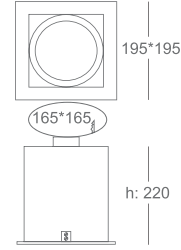

06.4600



06.4531 QR-111  
06.4531 CDM-R 111  
06.4526 CDM-R PAR  
06.4521 CDM-T G12

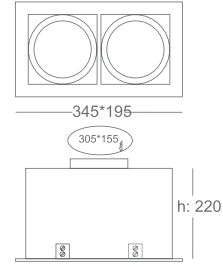

- Metal Kasa, Alüminyum Çerçeve
- Hareketli, Çok Yönlü
- Çoklu Ampul Seçimi
- Elektronik Balasta Uygun
- Ampül: CDM-T / CDM-R / QR 111
- MAX: 50-75-150W
- Kullanım Alanları:  
Mağaza, Showroom, Galeri,  
Özel Alanlar



## 06.4601

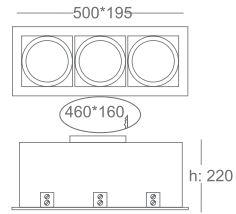

06.4531 QR-111  
 06.4531 CDM-R 111  
 06.4526 CDM-R PAR  
 06.4521 CDM-T G12



## 06.4602

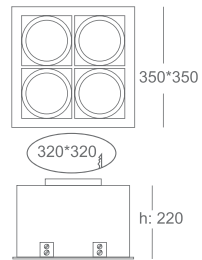

06.4531 QR-111  
 06.4531 CDM-R 111  
 06.4526 CDM-R PAR  
 06.4521 CDM-T G12



06.4522



06.4521



06.4526



06.4531



# PROFESYONEL AYDINLATMALAR

06.4605

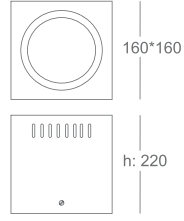

06.4531 QR-111  
06.4531 CDM-R 111  
06.4526 CDM-R PAR  
06.4521 CDM-T G12

06.4606

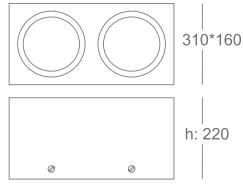

06.4531 QR-111  
06.4531 CDM-R 111  
06.4526 CDM-R PAR  
06.4521 CDM-T G12

06.4607

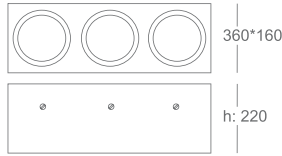

06.4531 QR-111  
06.4531 CDM-R 111  
06.4526 CDM-R PAR  
06.4521 CDM-T G12

06.4522



06.4521



06.4526



06.4531



- Metal Kasa, Alüminyum Çerçeve
- Hareketli, Çok Yönlü
- Çoklu Ampul Seçimi
- Elektronik Balasta Uygun
- Kullanım Alanları:  
Mağaza, Showroom, Galeri,  
Özel Alanlar



# PROFESYONEL AYDINLATMALAR



- Metal Kasa,
- Alüminyum Ring Hareketli, Focuslu
- Çoklu Ampul Seçimi
- Elektronik Balasta Uygun
- Ampül: MR16
- MAX: 50W
- Kullanım Alanları:  
Mağaza, Showroom, Galeri,  
Özel Alanlar

| F | | | 0,5m | | IP20 |

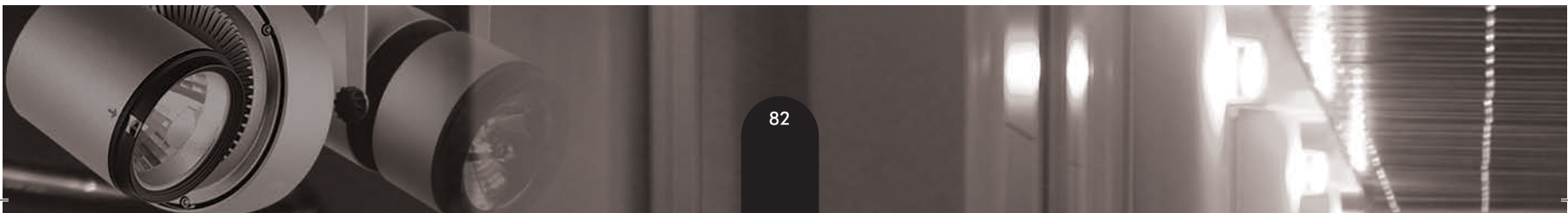

06.4621

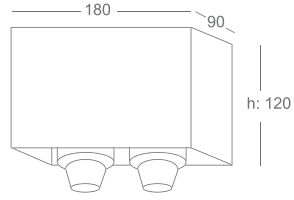

06.4622

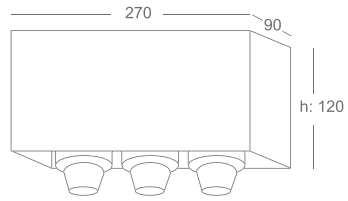

06.4623

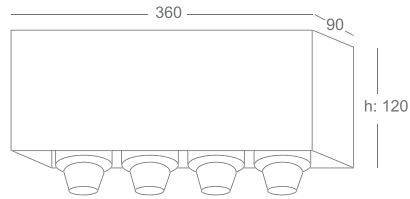

# PROFESYONEL AYDINLATMALAR

06.6034S

06.6034G

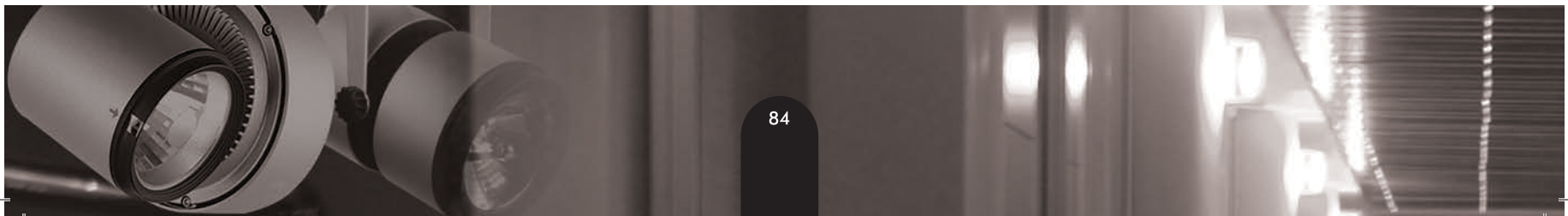
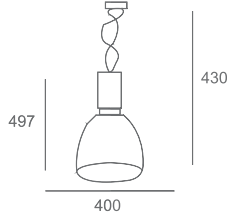

06.6037

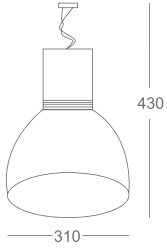

06.6038

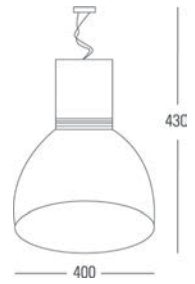

06.6036

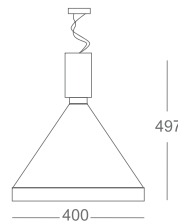

- Alüminyum/Polycarbon Gövde
- Sarkıt
- Elektronik Balasta Uygun
- Duy: G12 / G8.5
- Ampül: CDM-T / CDM-TC
- MAX: 70-150W
- Kullanım Alanları:  
Mağaza, Showroom, Galeri,  
Özel Alanlar

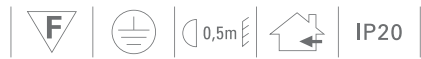

# DOWNLIGHT

Tüm Dengelerin  
Başlangıç Noktası

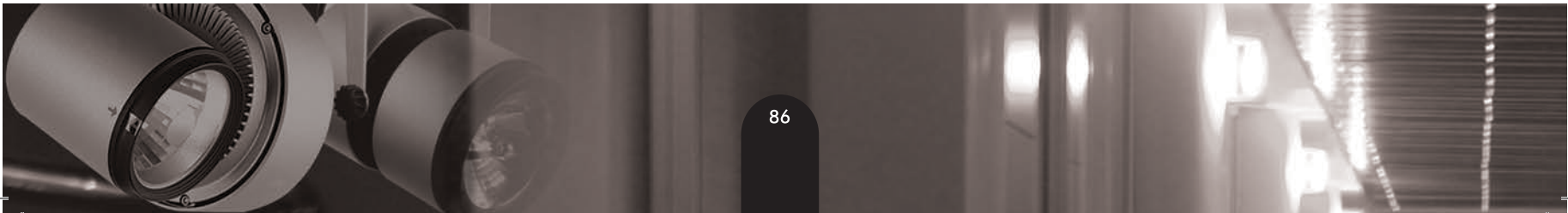

00.0060

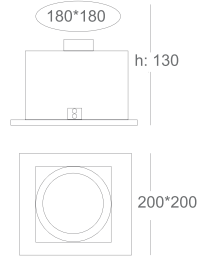

00.0061

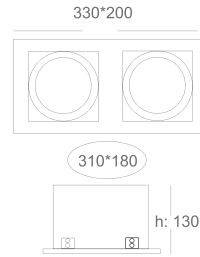

00.0062

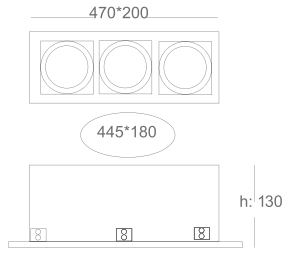

- Metal Gövde
- Parlak Reflektör
- Pleksi Difüzör
- Elektronik Balasta Uygun
- Duy: G24d
- Ampul: PLC
- MAX:18-26W
- Kullanım Alanları: Okul  
Ofis, Mağaza, Galeri,

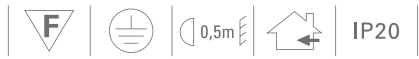

# DOWNLIGHT

Yüksek Tavanda  
Işık Verimliliği

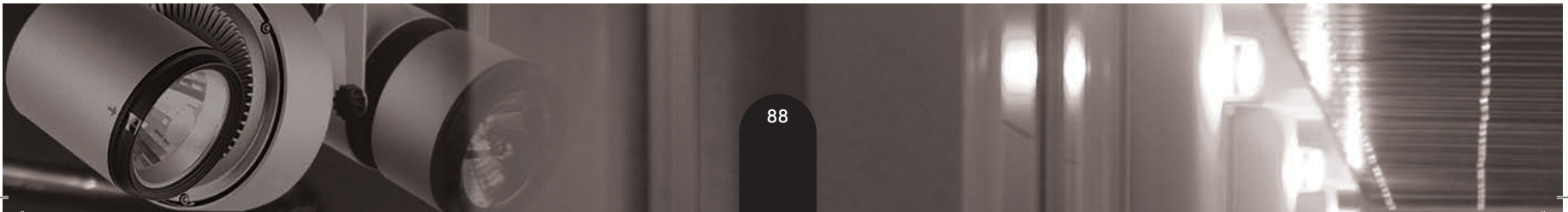

Kolay Müdahale,  
Basit Ampul Deęiřimi

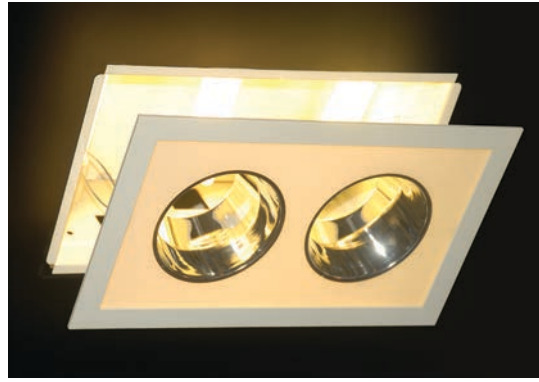

Derinlik Hissi,  
Sadelik,  
Homojenize Aydınlatma



# DOWNLIGHT

---

## Ofis Aydınlatma

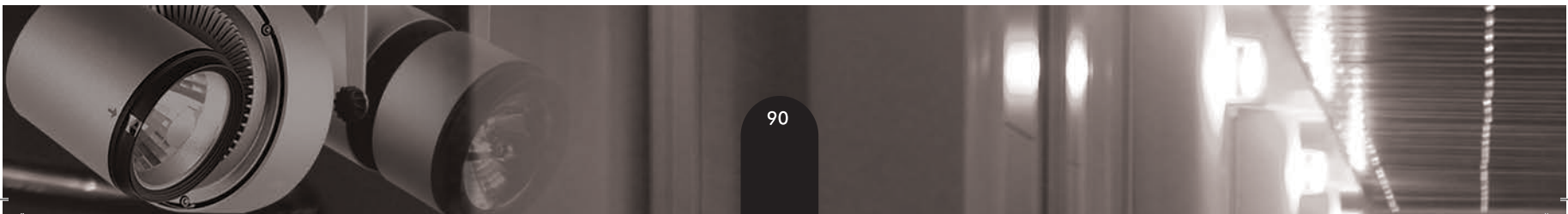

00.0065

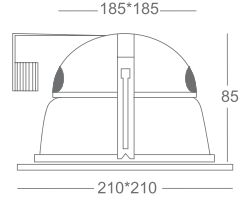

00.0066

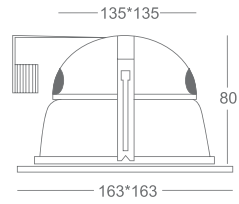

00.0067

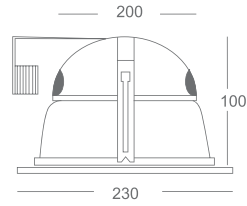

00.0068

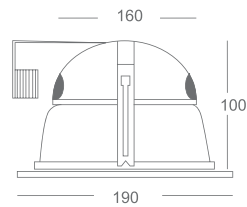

- Metal Gövde
  - Parlak Reflektör
  - Dekoratif Cam Difüzör
  - Elektronik Balasta Uygun
  - Duy: G24d
  - Ampul: PLC
  - MAX: 18-26W
- Kullanım Alanları:  
Ofis, Mağaza, Galeri,

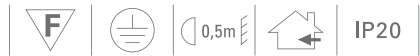

# DOWNLIGHT

00.0027



00.0027-01



00.0027-02

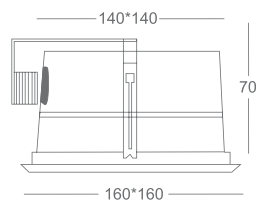

00.0028



00.0028-1



00.0028-2

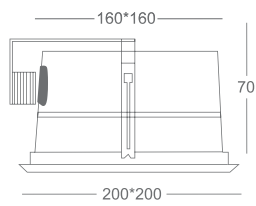

- Metal Gövde
- Parlak Reflektör
- Dekoratif Cam Difüzör
- Elektronik Balasta Uygun
- Duy: G24d
- Ampul: PLC
- MAX: 18-26W

Kullanım Alanları:  
Ofis, Mağaza, Galeri,

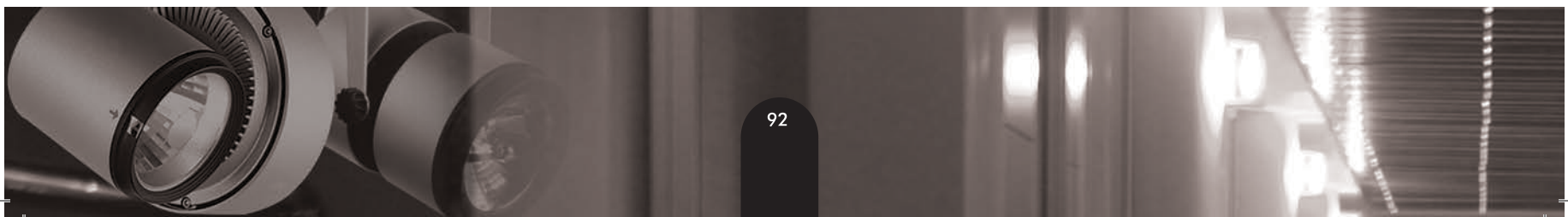
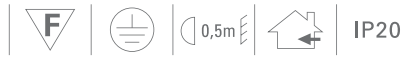

00.0090

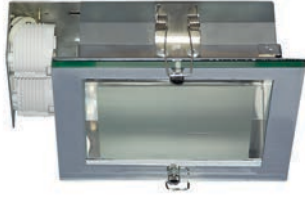

00.0089

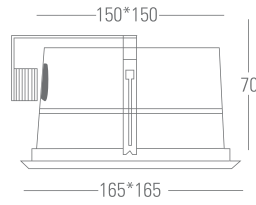

00.0023



00.0024

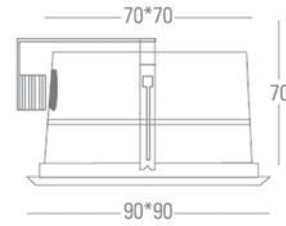

- Metal Gvde
- Parlak Reflektr
- Dekoratif Cam Difzr
- Elektronik Balasta Uygun
- Duy: G24d/ E27
- Ampul: PLC
- MAX:10-13-18W

Kullanım Alanları:

Ofis, Mağaza, Galeri,

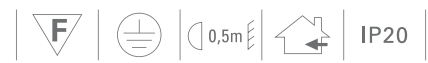

# DOWNLIGHT

00.0070

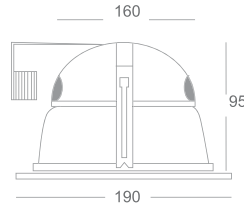

00.0071

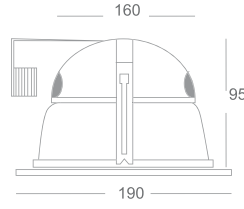

00.0073

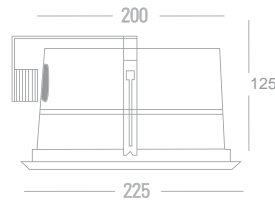

- Metal Gvde
- Parlak Reflektr
- Dekoratif Cam Difzr
- Elektronik Balasta Uygun
- Duy: G24d
- Ampul: PLC
- MAX:18-26W

Kullanım Alanları:  
Ofis, Mağaza, Galeri,

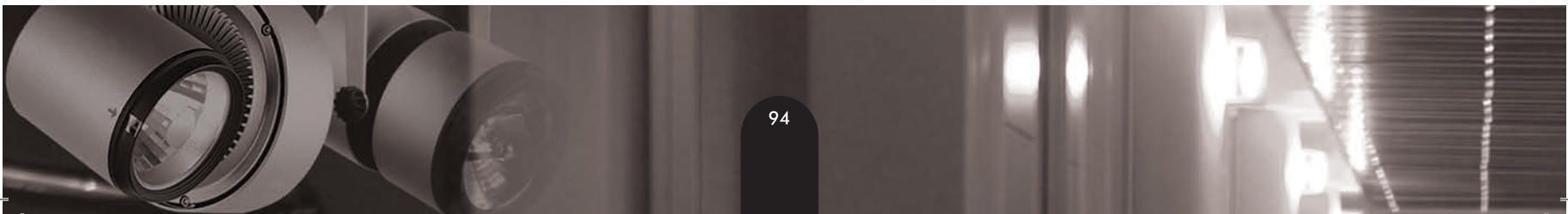

00.0105

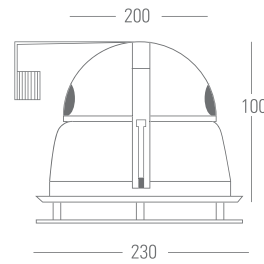

00.0106

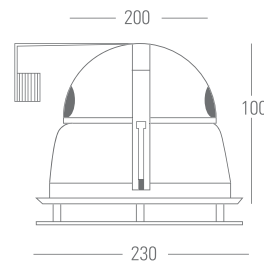

00.0082

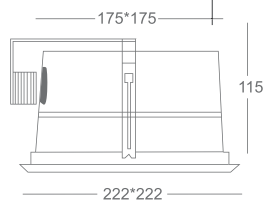

# DOWNLIGHT | Hamam-SPA

00.2077

E27

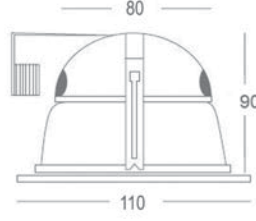

00.2521

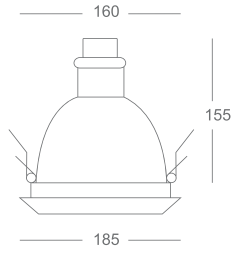

00.2501

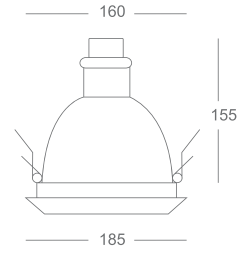

00.2531

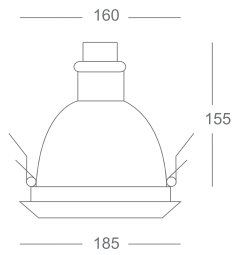

- Metal Gövde
- Parlak Reflektör
- Elektronik Balasta Uygun
- Duy: G24d / E27
- Ampul: PLC
- MAX:13-18-26W
- Kullanım Alanları:  
Ofis, Mağaza, Galeri,

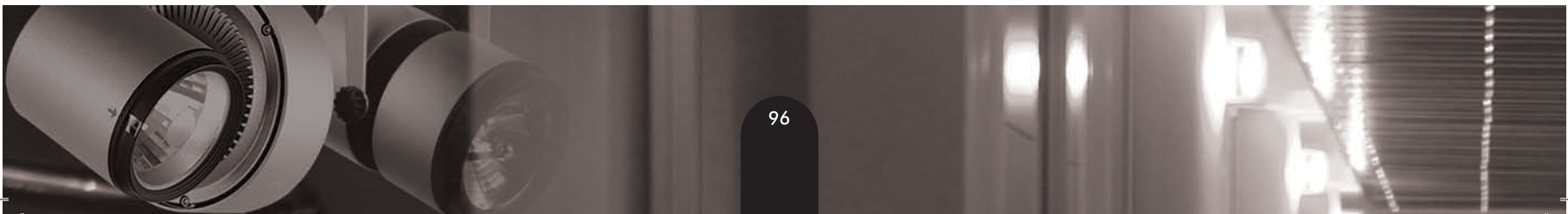
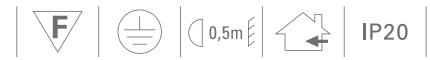



00.0059

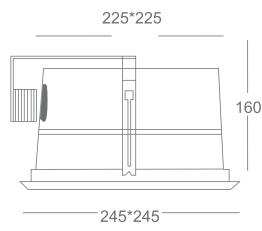

00.0110

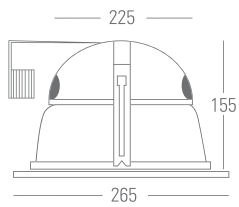

00.0094



00.0097

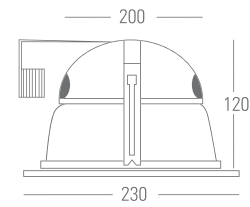

# DOWNLIGHT



- Metal Gövde
- Parlak Reflektör
- Dekoratif Cam Difüzör
- Elektronik Balasta Uygun
- Duy: G24d
- Ampul: PLC
- MAX:18-26W

Kullanım Alanları:  
Ofis, Mağaza, Galeri,

|  |  |  0,5m |  | IP20 |

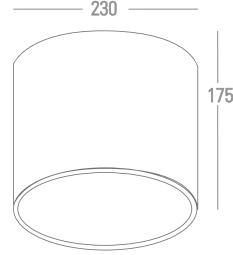

00.0053

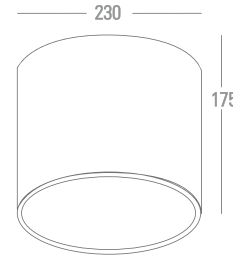

00.0054

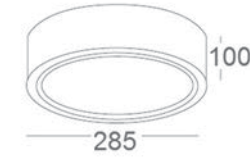

00.0088

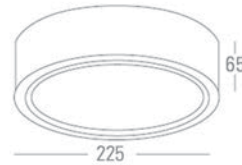

00.0050

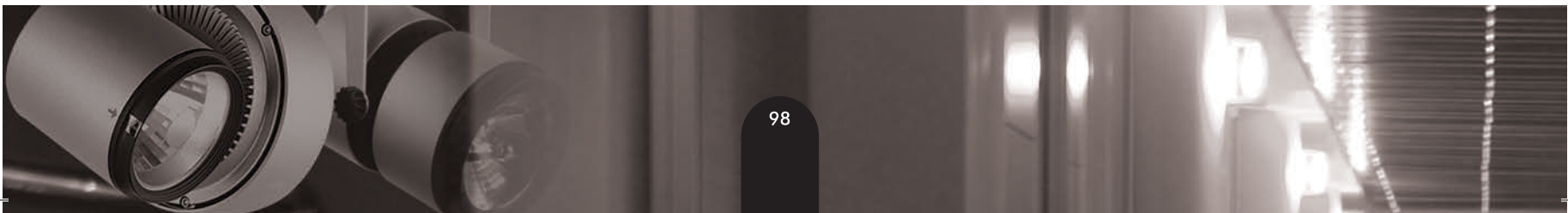

00.2092

00.2093

00.2094



<b>00.2092</b>	2x18W PLC	G24d 1-2 - E27	W	Ø: 190	⊙: 160	h: 105
<b>00.2093</b>	2x18W PLC	G24d 1-2 - E27	NM	Ø: 190	⊙: 160	h: 105
<b>00.2094</b>	2x18W PLC	G24d 1-2 - E27	CP	Ø: 190	⊙: 160	h: 105

00.2096

00.2097

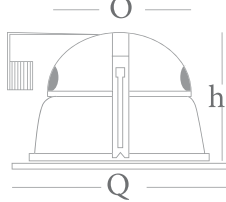

<b>00.2096</b>	2x26W PLC	G24d 1-2 / E27	White	Q : 230	O : 195	h:115
<b>00.2097</b>	2x26W PLC	G24d 1-2 / E27	Ni. Mat	Q : 230	O : 195	h:115

- Metal Gövde
- Parlak Reflektör
- Dekoratif Cam Difüzör
- Elektronik Balasta Uygun
- Duy: G24d
- Ampul: PLC
- MAX:13-18W / 18-26W

Kullanım Alanları:

Ofis, Mağaza, Galeri,

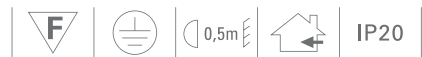

# DOWNLIGHT

00.2086

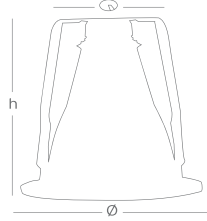

00.2089

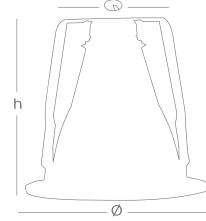

KOD	AMPÜL	DUY	RENK	ÖLÇÜ DETAYI		
00.2089	1x26W PLC	G24d 1-2 E27	W	Ø:180	Ø:145	h:195
00.2090	1x26W PLC	G24d 1-2 E27	NM	Ø:180	Ø:145	h:195
00.2091	1x26W PLC	G24d 1-2 E27	CP	Ø:180	Ø:145	h:195
00.2086	1x18W PLC	G24d 1-2 E27	W	Ø:145	Ø:115	h:175
00.2087	1x18W PLC	G24d 1-2 E27	NM	Ø:145	Ø:115	h:175
00.2088	1x18W PLC	G24d 1-2 E27	CP	Ø:145	Ø:115	h:175

- Metal Gövde
- Parlak Reflektör
- Dekoratif Cam Difüzör
- Elektronik Balasta Uygun
- Duy: G24d
- Ampul: PLC
- MAX:18-26W

Kullanım Alanları:

Ofis, Mağaza, Galeri,

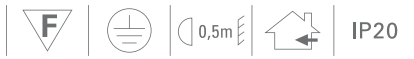

00.2088

00.2087



00.2090

00.2091

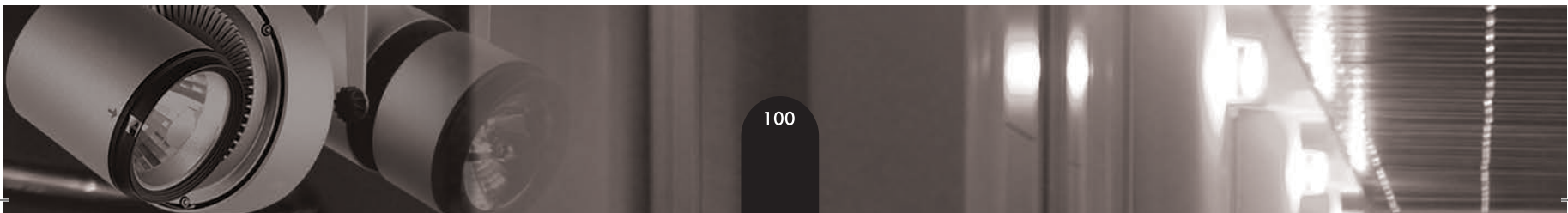

00.2070

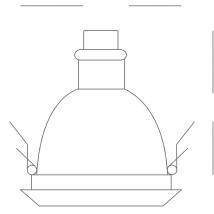
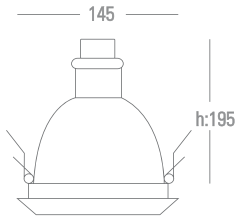

00.2071



00.2080



00.2081



00.2082



KOD	AMPÜL	DUY	RENK	ÖLÇÜ DETAYI		
00.2080	10W PLC	G24d 1-2 E27	W	Ø:100	⊘:70	h:100-125
00.2081	10W PLC	G24d 1-2 E27	NM	Ø:100	⊘:70	h:100-125
00.2082	10W PLC	G24d 1-2 E27	CP	Ø:100	⊘:70	h:100-125
00.2083	1x13W PLC	G24d 1-2 E27	W	Ø:120	⊘:90	h:105-135
00.2084	1x13W PLC	G24d 1-2 E27	NM	Ø:120	⊘:90	h:105-135
00.2085	1x13W PLC	G24d 1-2 E27	CP	Ø:120	⊘:90	h:105-135
00.2070	1x10W PLC	G24d 1-2 E27	W	Ø:95	⊘:65	h:95-120
00.2071	1x13W PLC	G24d 1-2 E27	W	Ø:105	⊘:75	h:105

00.2083



00.2084



00.2085



# DOWNLIGHT T5

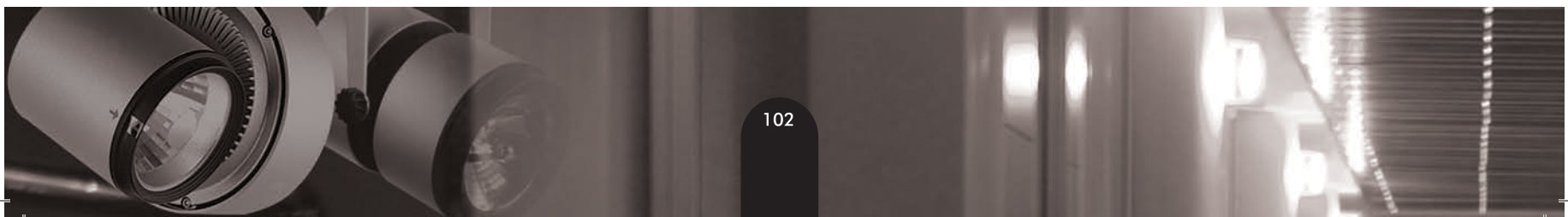

- Alüminyum Gövde
- Opal Difüzör
- Elektronik Balasta Uygun
- Duy: 2GX 13
- Ampül: T5 SİMİT FL
- MAX: 40-55W
- Kullanım Alanları: Ofis,  
Mağaza, Showroom, Galeri, Okul  
Özel Alanlar

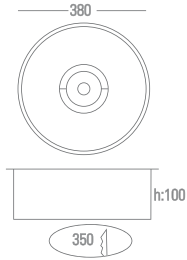

 0,5m
  IP20

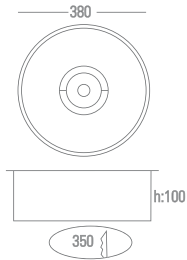

B.1120 -T5

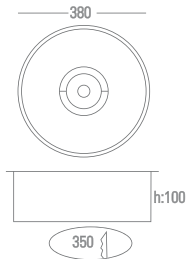

B.1120 -LED



B.1120 -T5 + CDM-R111



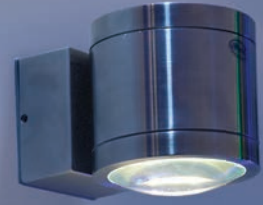
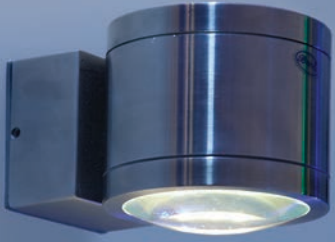

S T U D I O  
*B*ESTAR  
L I G H T I N G

*BESTAR*.com.tr

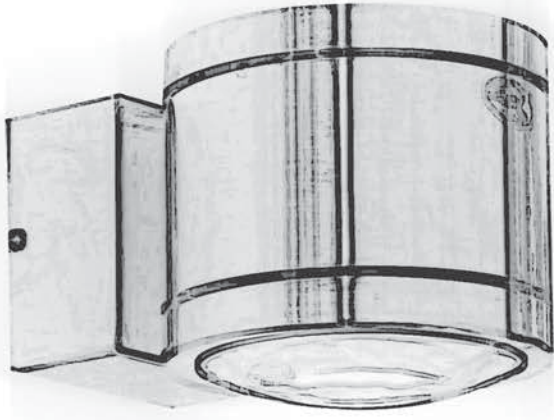

## LED AYDINLATMA

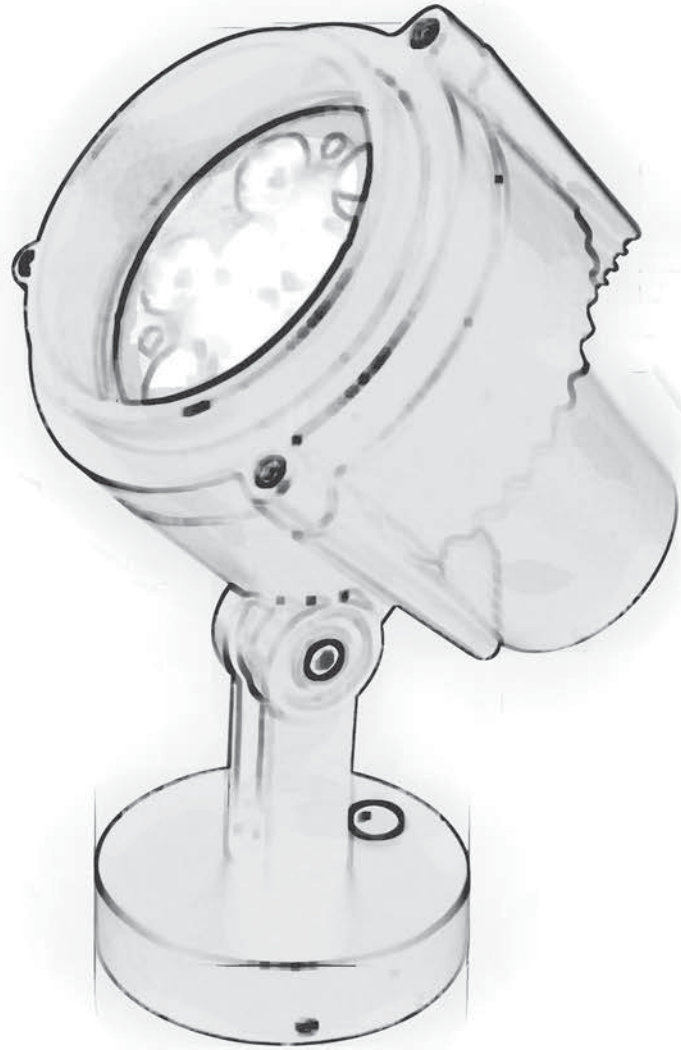

# LED SPOTLAR

## Geleceğin Aydınlatması

04.0056



- Sıva Üstü
- Alüminyum Gövde
- 6x1 W Power LED
- Multi Lens-Alüminyum Soğutucu
- Cree LED (USA)
- Kullanım Alanları:  
Ev, Ofis, Mağaza,

LED | F | ⚡ | 0,5m | 🏠 | IP44

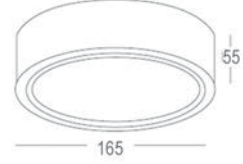

04.4610L



- Sıva Altı
- Alüminyum Gövde
- 9x1 W Power LED
- Multi Lens-Alüminyum Soğutucu
- Cree LED (USA)
- Kullanım Alanları:  
Ev, Ofis, Mağaza,

LED | F | ⚡ | 0,5m | 🏠 | IP20

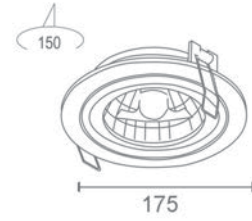

04.4546L



- Sıva Altı
- Alüminyum Gövde
- 9x1 W Power LED
- Multi Lens-Alüminyum Soğutucu
- Cree LED (USA)
- Kullanım Alanları:  
Ev, Ofis, Mağaza,

LED | F | ⚡ | 0,5m | 🏠 | IP20

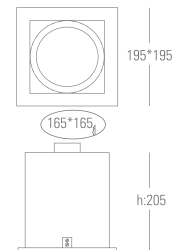

004.0015



- Sıva Altı
- Alüminyum Gövde
- Alüminyum Reflektör
- 10W COB LED
- BridgeLUX LED (USA)
- Kullanım Alanları:  
Ev, Ofis, Mağaza,

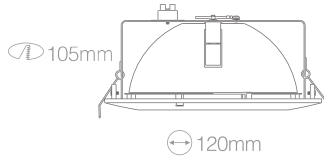

004.0055



- Sıva Altı
- Alüminyum Gövde
- Opal Difüzör
- 20x1W LED
- Cree LED (USA)
- Kullanım Alanları:  
Ev, Ofis, Mağaza,

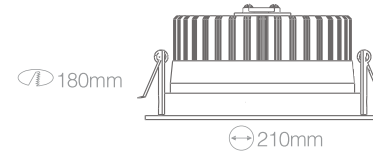

BESTAR.com.tr

# LED SPOTLAR

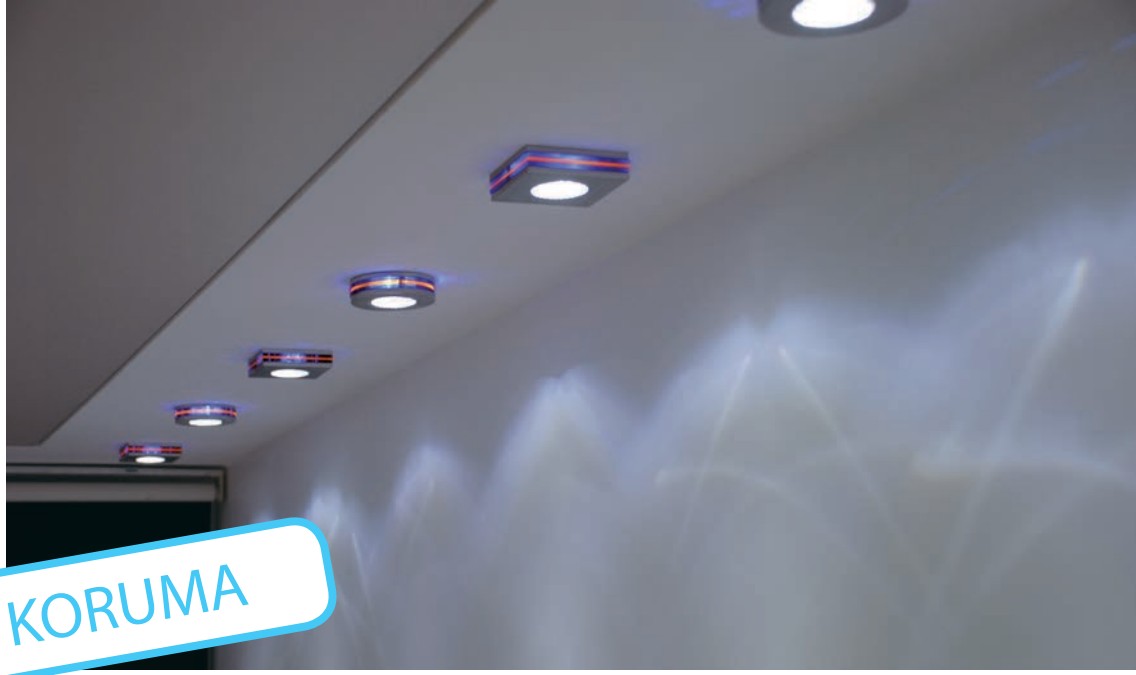

IP KORUMA

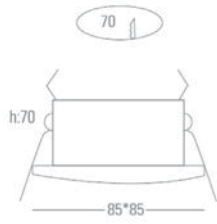

IP65 04.0202



- Alüminyum Gövde
- Cam Difüzör
- 3x1W Power LED
- Cree-Osram LED
- Kullanım Alanları:  
Ev, Ofis, Mağaza,



IP44 02.4173L



IP44 02.4175L



IP44 02.4174L



IP44 02.1094L



02.4240L

02.1091L

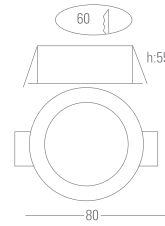
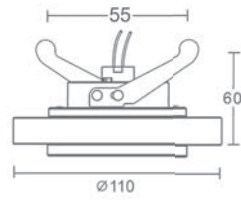

02.0161L

02.0163L

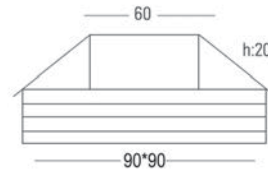
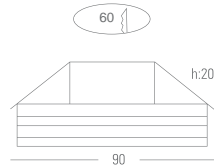

- Alüminyum Gövde
- Cam Difüzör
- 3x1W Power LED
- Cree-Osram LED
- Kullanım Alanları:  
Ev, Ofis, Mağaza,

LED | F | ⚡ | 0,5m | 🏠 | IP20

# LED SPOTLAR

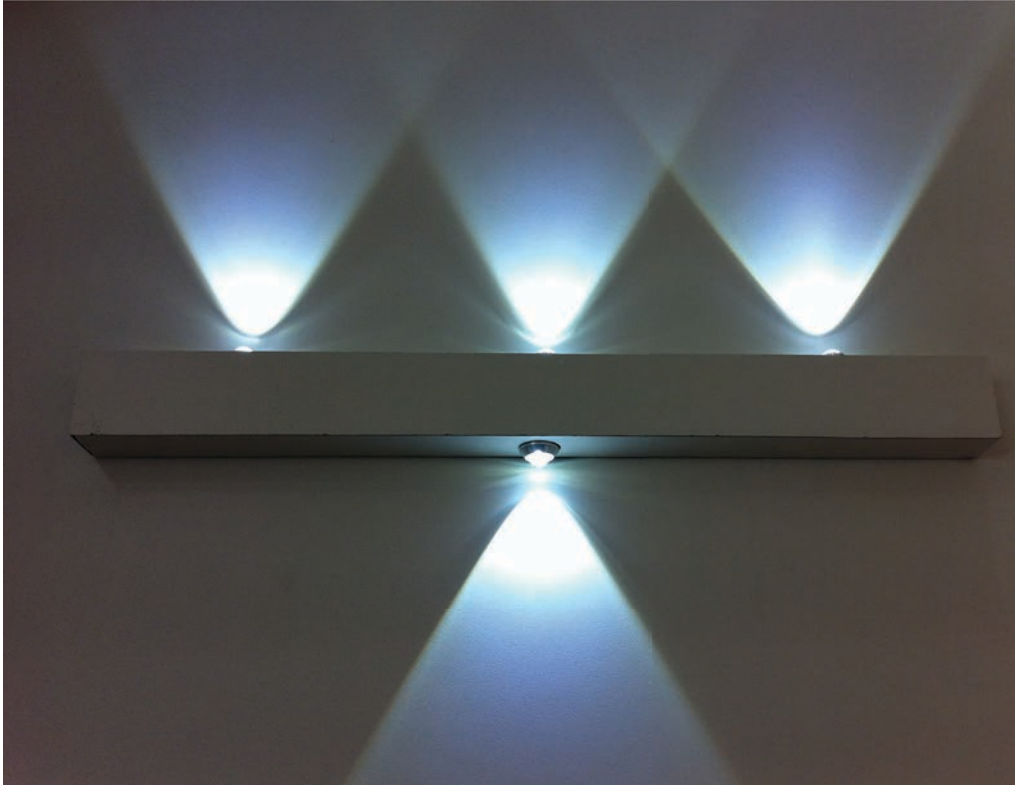

04.4090



04.4098

04.4099

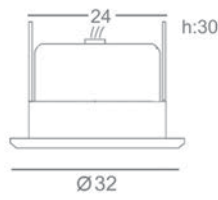
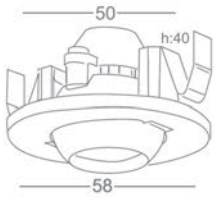

- Paslanmaz Gövde
- Power LED
- Optik Lens/Mercek
- Cree LED (USA)
- Kullanım Alanları:  
Ev, Ofis, Mağaza,

LED | F |  |  0,5m |  | IP20

## Kuyumcu Tezgahı Lambaları



04.5512

04.5511



- Alüminyum Gövde
- Hareketli Başlık
- Power LED
- Optik LENS
- Cree LED (USA)
- Kullanım Alanları:  
Ev, Ofis, Mağaza,

LED | F | ⚡ | 0,5m | IP20



04.5555



02.4041L



02.4043L



02.4042L



02.4044L

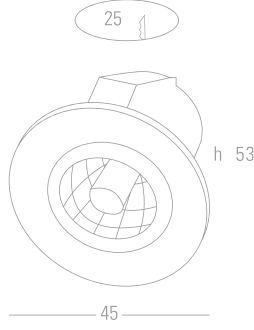

- Yıldız Spot
- Zamak Gövde
- Parlak Reflektör
- 1W Power LED
- Kullanım Alanları:  
Ev, Ofis, Mağaza,

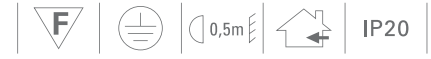

02.4086L

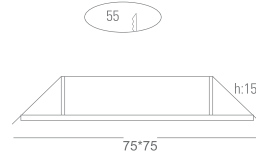
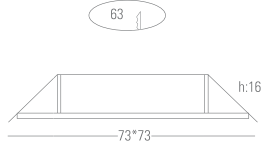

02.5361L



02.4091L

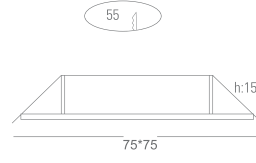
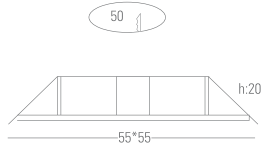

02.5360L



02.5381L

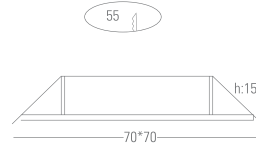
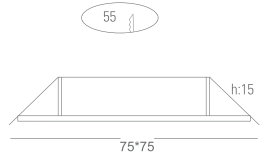

02.1177L



02.1172L



- Mob Spot (Mobilya)
- Cam Difüzör
- 1W Power LED
- Kullanım Alanları:  
Dolap İçi, Ahşap Tezgah Altı

LED | F | ⚡ | 0,5m | IP20

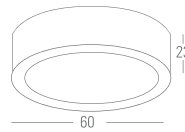

# LED SPOTLAR

06.4509L

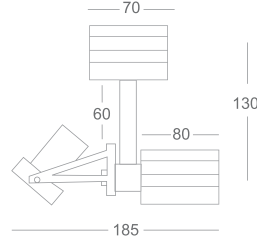
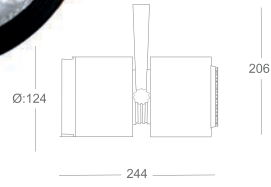

06.4246L



06.4245L



06.6080L

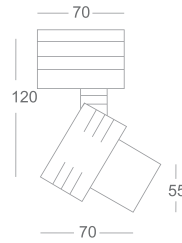
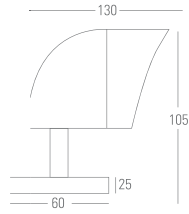

06.2019L

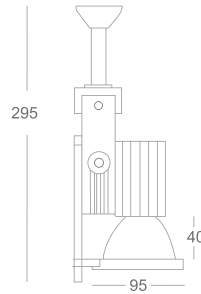

- Alüminyum Gövde
- Multilens
- Power LED
- Rötatif Hareketli
- Kullanım Alanları:  
Ev, Ofis, Mağaza,

LED | F |  |  0,5m |  IP20



- Paslanmaz Gövde
- Hareketli Aplik
- Power LED spot
- Kullanım Alanları:  
Ev, Ofis, Mağaza,

| LED | F | ⚡ | 0.5m | 🏠 | IP20 |

04.6070



04.0010

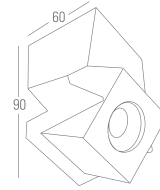

04.6054

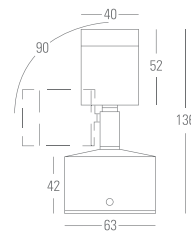

# LED SPOTLAR

03.4327L



- Alüminyum Gövde
- Power LED Ampül
- Sıva Üstü
- Kolay Montaj

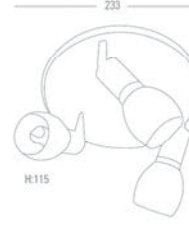

03.4328L

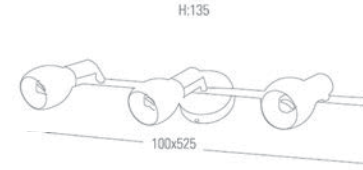

03.4329L

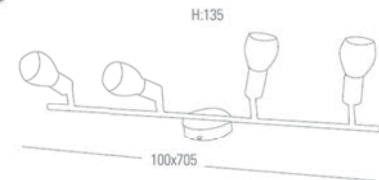

## İki Yön LED Aplik

04.6078

IP44

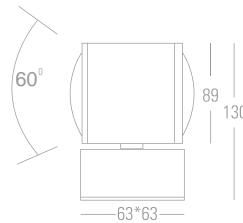

- Paslanmaz Gövde (304)
- LED Power 6x1W 8V
- İki Yönlü LED
- IP44
- Kullanım Alanları: Villa, Ev, Ofis, Mağaza,

## RGB Renk Cümbüşü

04.6010

IP55

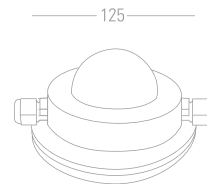
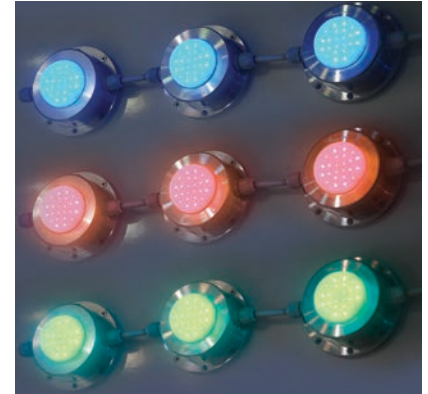

- Alüminyum Gövde
- RGB LED
- Seri Bağlantı Sonsuz
- IP55 Koruma
- Kolay Montaj
- Kumandasız bağlantısız

# LED DUVAR ARMATÜRLERİ

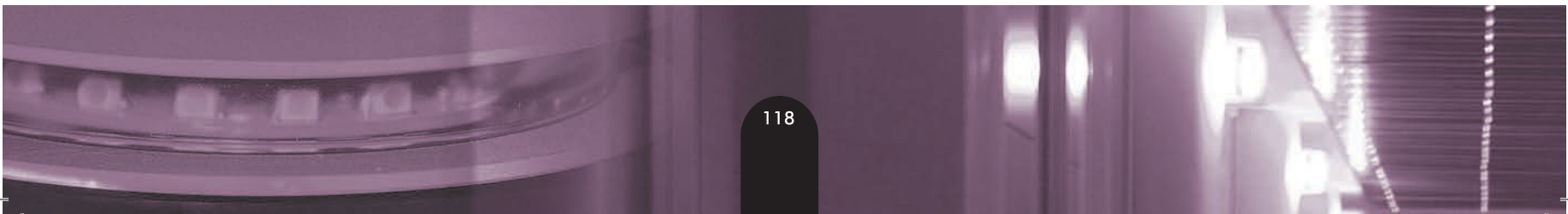

04.4094

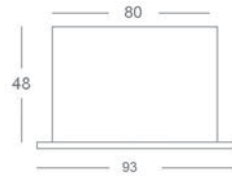

04.4093

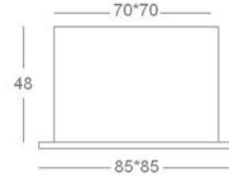

04.4093SÜ



- Alüminyum gövde
- Asimetrik
- Power LED
- Plastik Montaj Kasası
- Kullanım Alanları:  
Ev, Ofis, Mağaza,

# LED DUVAR ARMATÜRLERİ

---



IP55

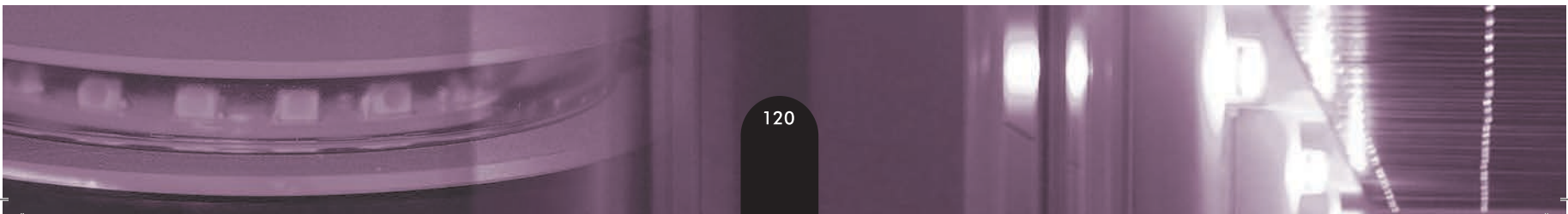

04.1050G

IP55

04.1050B



- Alüminyum Gövde
- AS Difüzör
- LED Power 6x1W
- LED Driver
- IP55 Koruma
- Kullanım Alanları: Villa,  
Ev, Ofis, Mağaza,

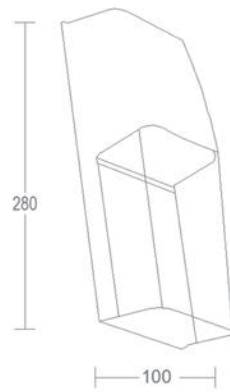

LED | 230V | F | 0,5m |



BESTAR.com.tr

# LED DUVAR ARMATÜRLERİ

04.4745



IP44

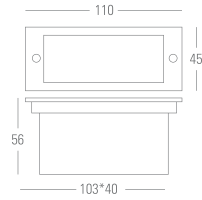

04.4746

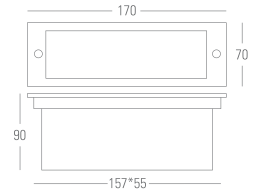

04.1191



Paslanmaz

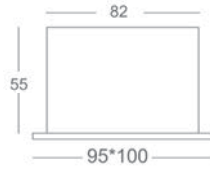

04.1190

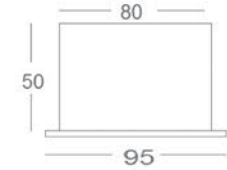

04.4147



04.4149

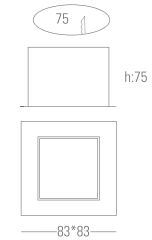

- Alüminyum Gövde
- LED 220V
- Endirekt Aydınlatma
- Kolay Montaj
- Kullanım Alanları: Villa, Ev, Ofis, Mağaza,



04.4072

04.4073

04.4074

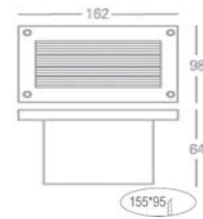
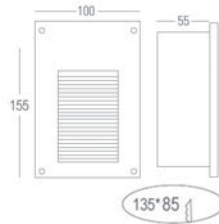
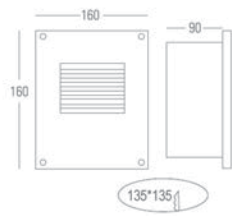

- Alüminyum Gövde ve Çerçeve
- LED 220V
- Endirekt Aydınlatma
- IP54
- Kolay Montaj
- Kullanım Alanları: Villa,  
Ev, Ofis, Mağaza,

LED | 220V | | | | | IP54

BESTAR.com.tr

# LED ARMATÜR

Islak Zemin için LED



04.4270 SOĞUK BEYAZ

SICAK BEYAZ 04.4271

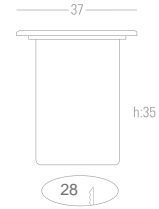
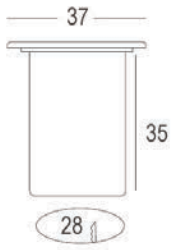

04.4275 SOĞUK BEYAZ

SICAK BEYAZ 04.4276

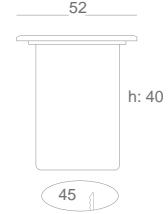

- Paslanmaz Çerçeve
- Paslanmaz Gövde
- Cam Difüzör
- SMD LED
- 12V Besleme
- Kullanım Alanları: Villa, Ev, Ofis, Mağaza,

LED | F | ⚡ | 0,5m | 🏠 | IP65

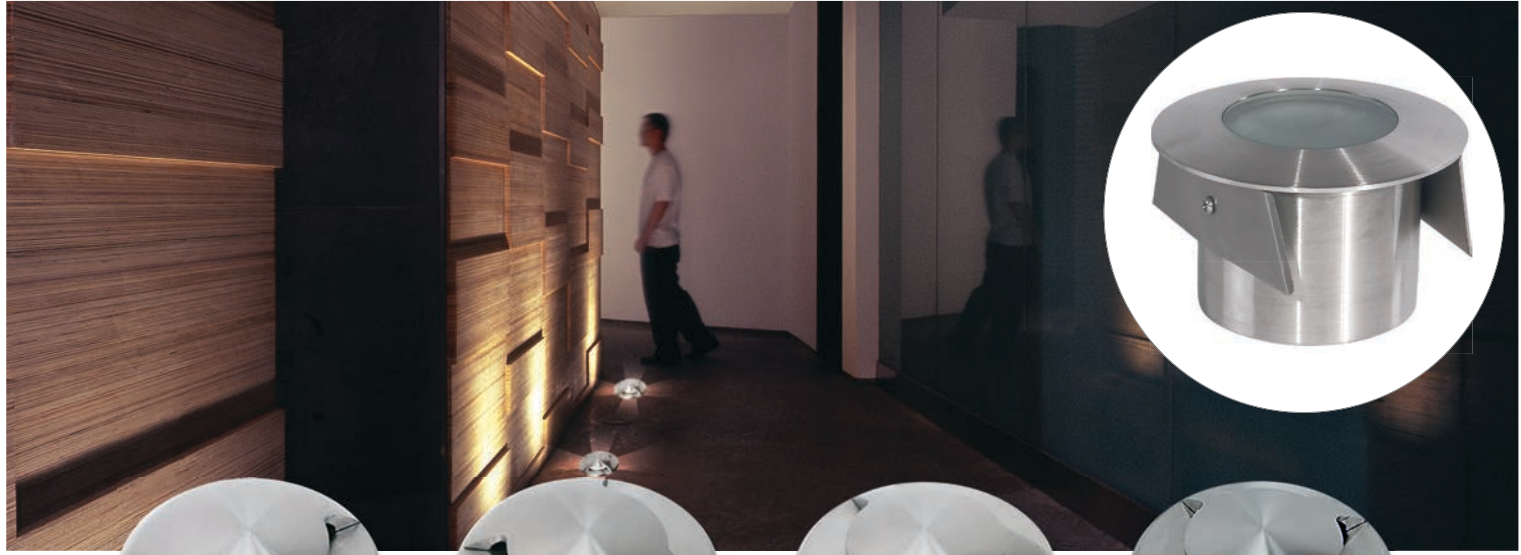

04.6068-1



04.6068-2



04.6068-3



04.6068-4

## 04.6068

- Paslanmaz 304 Kalite
- Plastik Montaj Kasası
- Cam Difüzör
- Power LED
- Kullanım Alanları: Villa,  
Ev, Ofis, Mağaza,

LED | F | ⚡ | 0,5m | IP65

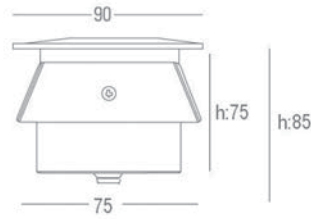

## 04.6067-1

## 04.6067-2

## 04.6067

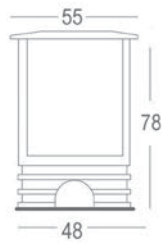

BESTAR.com.tr

# LED DUVAR ARMATÜRLERİ

02.4503GL

02.4503BL

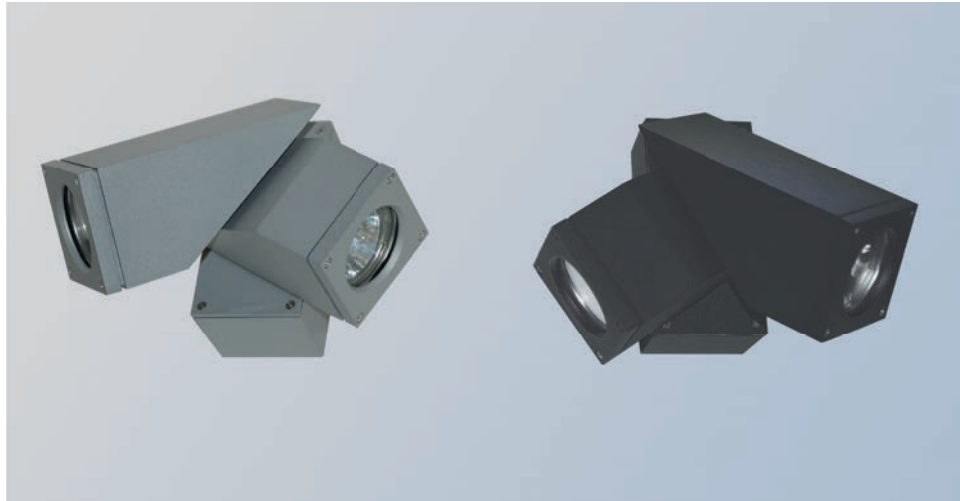
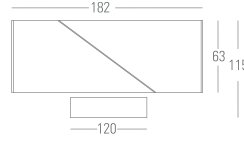

- Alüminyum Gövde
- Rötatif Hareketli
- İki Yönlü
- 3x1W + 3x1W LED
- Kullanım Alanları: Villa, Ev, Ofis, Mağaza,

LED |  |  |  | IP44



09.1210L



04.8057



**CE** Düşük voltajlı enerji tasarrufu ve yüksek parlaklık. Uluslararası standartlara uygun. Güvenli ve istikrarlı çalışma. Geleneksel aydınlatmaya kıyasla %90 enerji tasarrufu.

- Alüminyum Gövde
- Temperli Cam
- 9x1,5W Power LED
- Kullanım Alanları: Villa, Ev, Ofis, Mağaza,

LED | F | ⚡ | 0,5m | IP65

BESTAR.com.tr

# LED ÇİM LAMBALARI

02.4291L

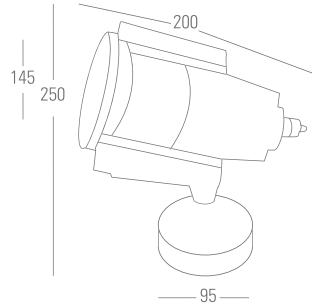

04.4314

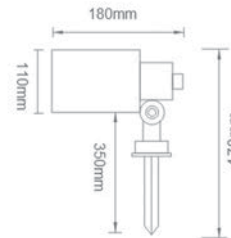

- Alüminyum Enjeksiyon Gövde
- Opsiyonel Aksesuar
- Temperli Cam
- Power LED
- Kullanım Alanları: Villa, Ev, Ofis, Mağaza,

LED | F | E | 0,5m | IP65



04.6090L

PİRİNÇ (BRASS)



09.4315L

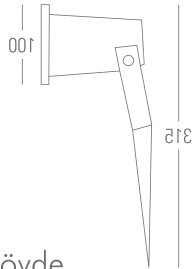

- Alüminyum Gövde
- Temperli Cam
- Power LED
- Kullanım Alanları: Villa, Ev, Ofis, Mağaza,

LED | F | ⚡ | 0,5mE | IP67

09.4293



09.4293T

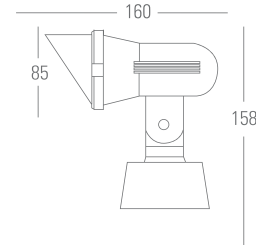

09.4293S



BESTAR.com.tr

# LEDLİ ZEMİN GÖMME

09.4298L

04.4299L

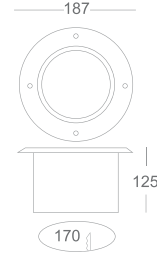
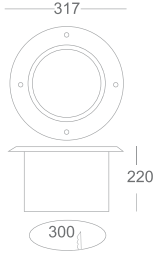

09.4278L

09.4279L

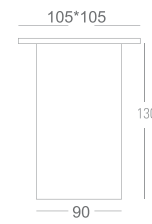

- Alüminyum Gövde
- Paslanmaz Çerçeve
- Plastik Muhafaza Kutusu
- Power LED
- Kullanım Alanları: Villa, Ev, Ofis, Mağaza,

LED | F | ⚡ | 0,5m | IP65

04.6075

04.6069

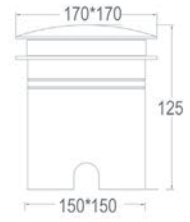

- Alüminyum Gövde
- Plastik Muhafaza Kutusu
- Çok Yönlü LED
- Kullanım Alanları: Villa,  
Ev, Ofis, Mağaza,

LED | F | ⚡ | 0,5m | 🏠 | IP65

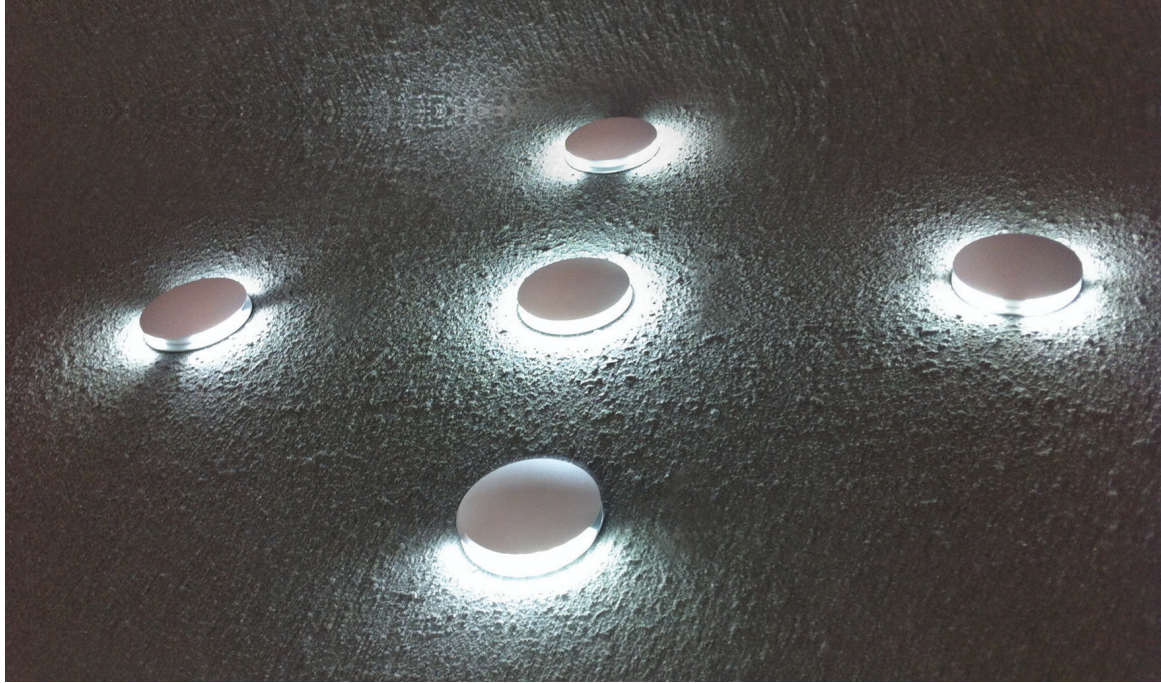

# LED SOKAK LAMBASI

04.8058



- LED Projektör
- Alüminyum Gövde
- Temperli Cam
- 60x1,5W Power LED
- Çok Farklı Açısal Özellik

| LED |  |  |  |  |  | IP65 |

04.2105

30W COB LED 5600K



04.2104

10W COB LED 5600K



# WALLWASHER

05

## B 9030

B 9030 MC	35 cm 12X2W LED bar tek renk
B 9030 RGB	35 cm 12X2W LED bar RGB
B 9030 1-10V	35 cm 12X2W LED bar RGB 1/10V
B 9030 DMX512	35 cm 12X2W LED bar RGB DMX 512



## B 9031

B 9031 MC	65 cm 24X2W LED bar tek renk
B 9031 RGB	65 cm 24X2W LED bar RGB
B 9031 1-10V	65 cm 24X2W LED bar RGB 1/10V
B 9031 DMX512	65 cm 24X2W LED bar RGB DMX 512



## B 9032

B 9032 MC	95 cm 36X2W LED bar tek renk
B 9032 RGB	95 cm 36X2W LED bar RGB
B 9032 1-10V	95 cm 36X2W LED bar RGB 1/10V
B 9032 DMX512	95 cm 36X2W LED bar RGB DMX 512



\*Tüm profillerimiz hava tahliye ventiline sahip olup, özel alaşımli alüminyumdur. Ledlerimiz CREE (Amerikan Malı) veya OS-RAM (Alman Malı) olup, 2W gücündedir. isteğe göre 10', 24' veya 40' lens olabilmektedir.

\*\*Elektronik komponent ve led chip fiyatlarının değişkenliğinden dolayı lütfen güncel fiyat isteyiniz.



BESTAR.com.tr

# HAVUZ LAMBALARI



013.1260

013.1250



- Alüminyum gövde
- Paslanmaz çerçeve
- 3x1W Power LED
- Temperli cam



013.1209 12V 300W PAR56  
013.1210 12V 90 LED

12V 100W G4 013.1211

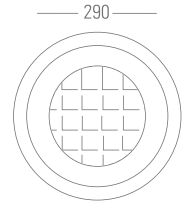
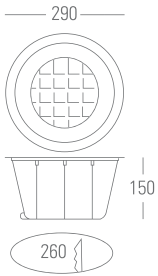

- ABS Çerçeve
- Polikarbon Difüzör
- Sıva Altı / Sıva Üstü

⚡ | ⚙️ | 5m | 🏠 | IP68



BESTAR.com.tr

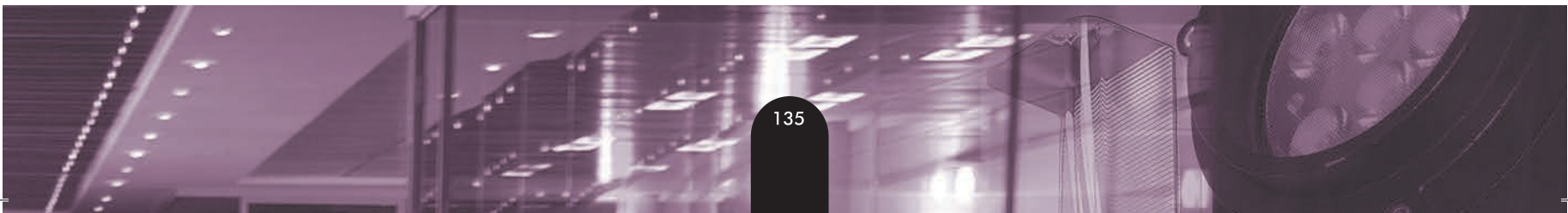

# LED SPOTLAR

04.6001



04.6004



04.6002



04.6007

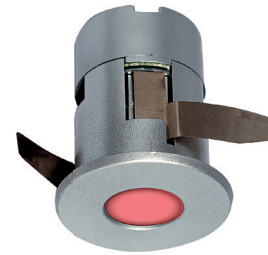

04.6005

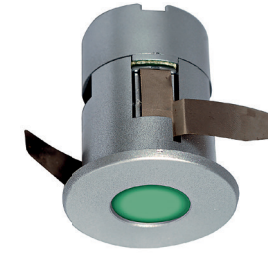

04.6008



- Alüminyum çerçeve
- Plastik gövde
- Kumlu pleksi cam
- Noktasal LED 220V

LED | F | ⚡ | 0,5m | 🏠 | IP20

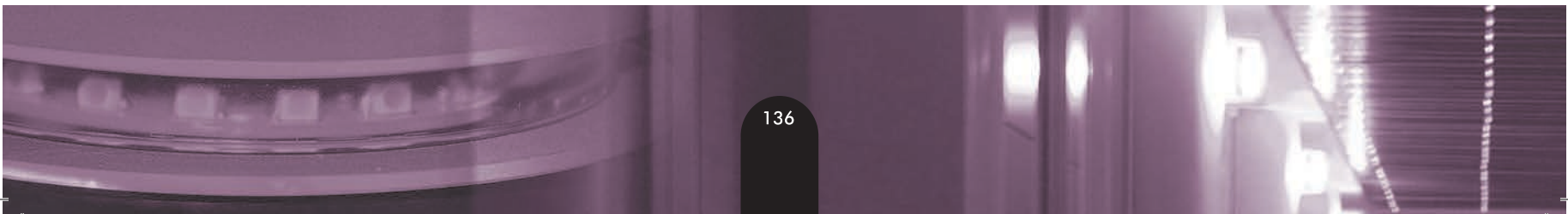

04.6011      04.6012      04.6013      04.6014      04.6015



04.6016      04.6017      04.6018      04.6019      04.6022



- Alüminyum çerçeve
- Plastik gövde
- Kumlu pleksi cam
- Noktasal LED 220V

LED | F | ⚡ | 0,5m | IP20



04.7031  
04.7030

SARI LED FİBER OPTİK  
BEYAZ LED FİBER OPTİK

04.7036  
04.7035

SARI LED FİBER OPTİK  
BEYAZ LED FİBER OPTİK

04.7038  
04.7037

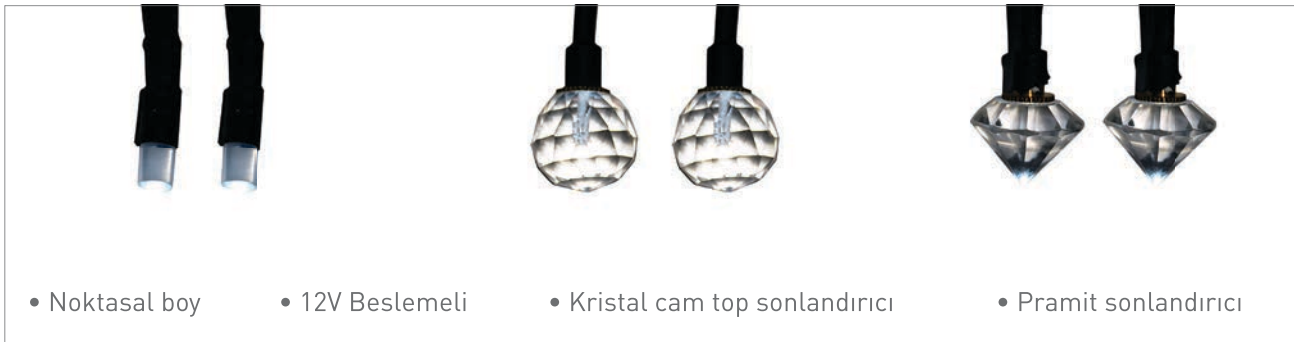

- Noktasal boy
- 12V Beslemeli
- Kristal cam top sonlandırıcı
- Primit sonlandırıcı

Kendinden LED'li 20 cm kablo

# LED AMPUL

**04.4096**

12V 350 MA3\*1W LED AMPUL



**04.4097**

12V 350 MA3\*1W LED AMPUL



**04.5094**

230V GU10 3\*1W SARI LED AMPUL



**04.5095**

230V GU10 3\*1W BEYAZ LED AMPUL



**04.5097**

230V E27 7W SARI LED AMPUL



**04.5098**

230V E27 7W BEYAZ LED AMPUL

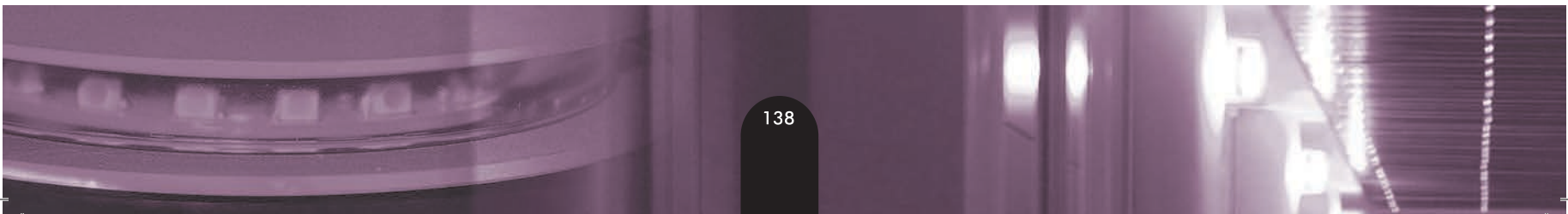
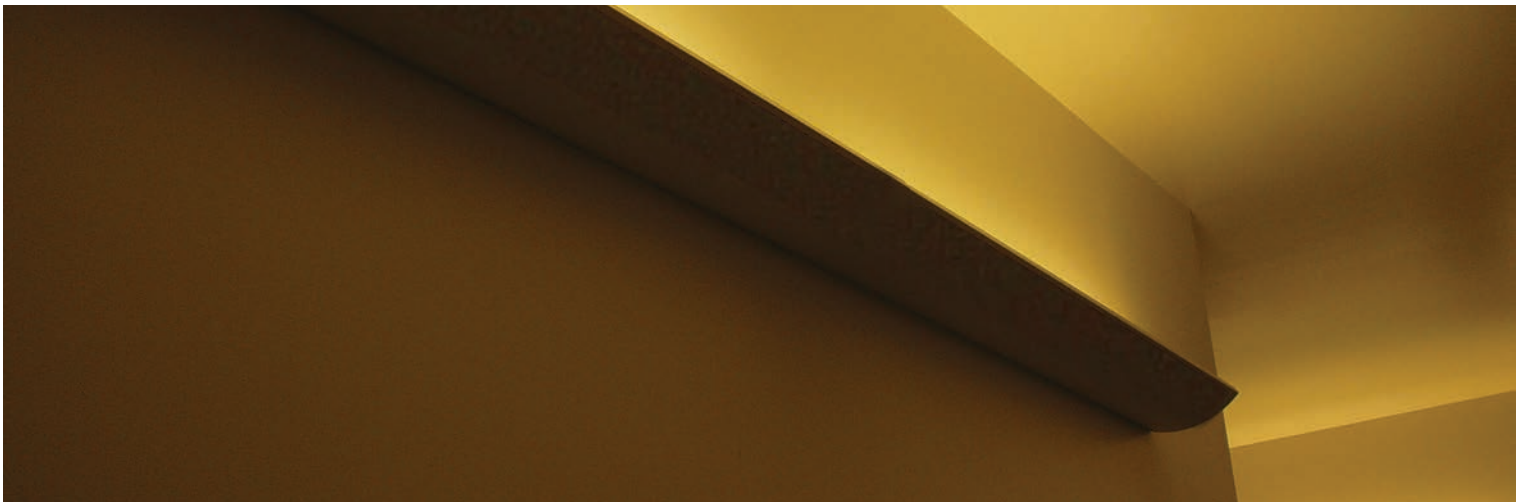

RGB LED

04.4735



RGB KONTROLLER

04.4736



12V TRAFÖ

04.4737



- Polycarbon gövde
- Epoksi izole
- 12V besleme
- Seri bağlantı

LED | F | 0,5m | IP67

04.4728

SNOW WHITE



04.4732

YEŞİL LED



04.4730

KIRMIZI LED



04.4731

MAVİ LED



04.4733

BEYAZ LED



04.4734

SARI LED

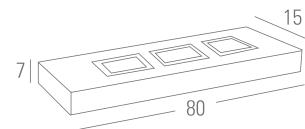



STUDIO  
*B*ESTAR  
LIGHTING

*B*ESTAR.com.tr

# FİBER OPTİK

---





FİBER OPTİK KABLO 011.7001



011.7002 IŞIK KAYNAĞI

FİBER OPTİK KİT 011.7005  
RGB011.7006 FİBER OPTİK KİT  
BEYAZ

011.7003

011.7004



- Fiber Optik Kablo 1 mm İzoleli
- LED Işık Kaynağı
- Fiber Optik Sonlandırıcı
- Fiber Optik Kristal Sonlandırıcı
- Noktasal ve Yıldız Efekt



LED | F | ⊕ | 0,5m | IP20

BESTAR.com.tr



STUDIO  
*B*ESTAR  
LIGHTING

*B*ESTAR.com.tr

## HARİCİ ARMATÜR

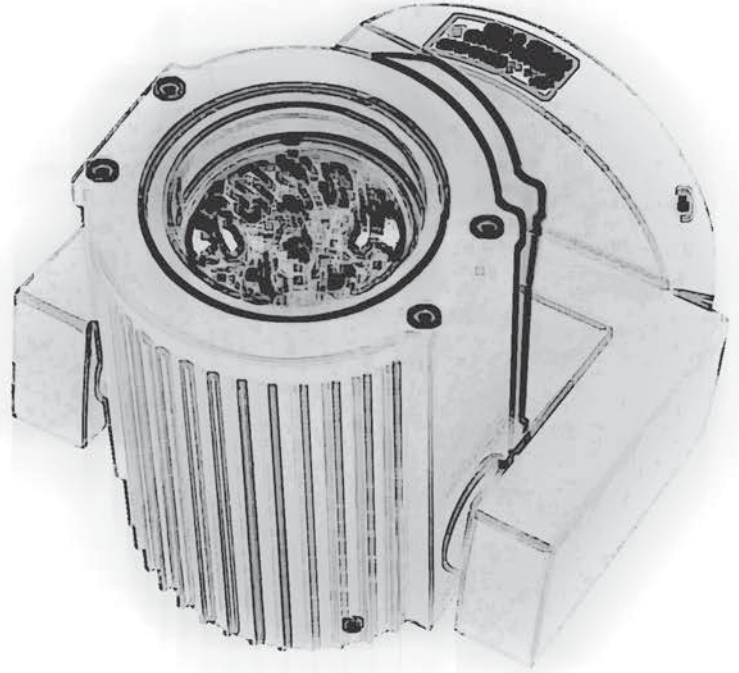
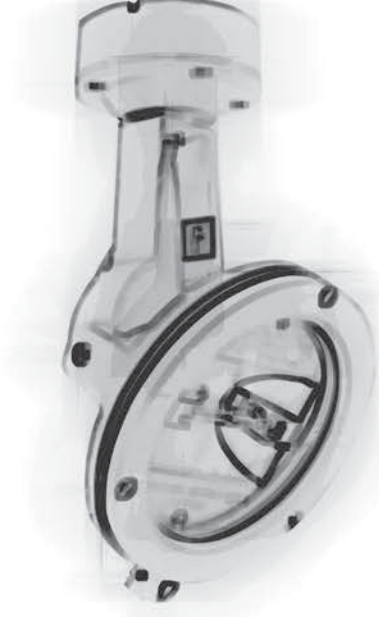

# HARİCİ ARMATÜRLER

Dışarıda Işık Var

09.4568

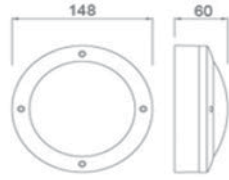

09.4569

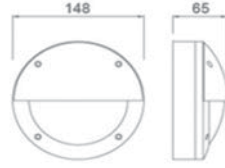

09.4566

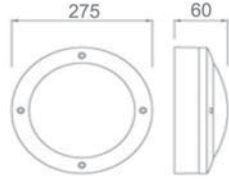

09.4567

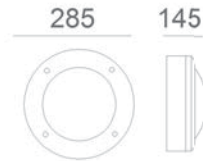

09.4586



- Alüminyum Enjeksiyon Gövde
- Polikarbon Cam
- Duy: E27/G4
- Harici Aplik
- Ampül: Enerji Tasarruflu

|  | MAX 60W |  |  |  |  | IP54 |

09.2188



09.2186

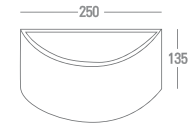

09.2187

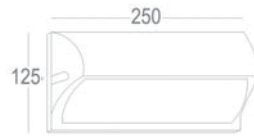

09.4554

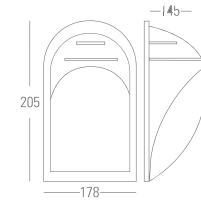

09.2189

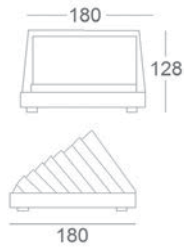

09.4591

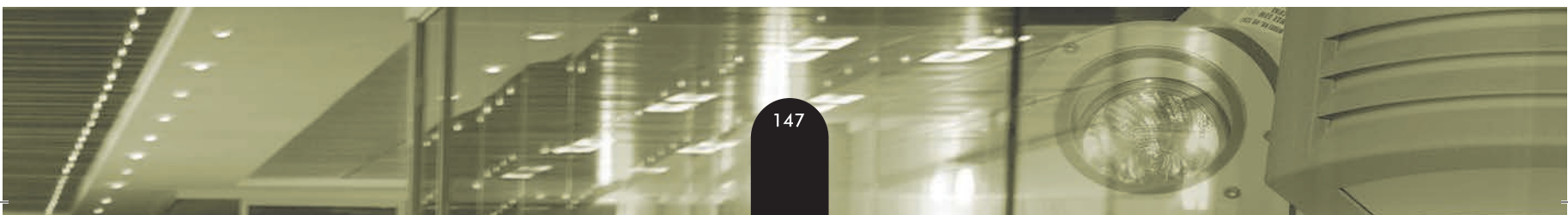
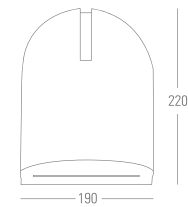

# HARİCİ ARMATÜRLER

09.3369

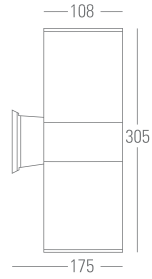

09.3372

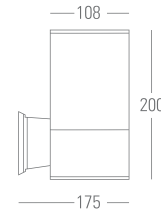

09.3376

- Alüminyum Enjeksiyon Gövde
- Polikarbon Cam
- Duy: E27/G4
- Harici Aplik
- Ampül: Enerji Tasarruflu / PAR30



09.3380

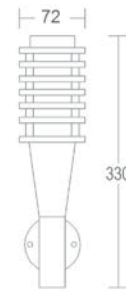

09.2119

09.2150

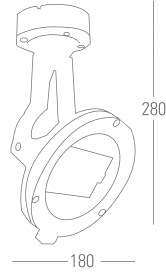

- Alüminyum Enjeksiyon Gövde
- Polikarbon Cam
- Duy: Rx7s / G12 / E27
- Harici Aplik
- Ampül: Halojen / Metal Halide



09.1297

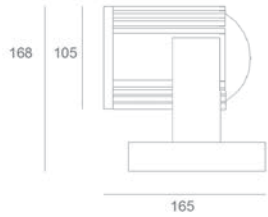

# HARİCİ ARMATÜRLER

09.4294

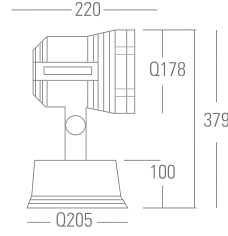

- Alüminyum Enjeksiyon Gövde
- Temperli Cam
- Rotatif Projektör
- Duy: G12
- Sıva Üstü
- Ampül: CDM-T



DUVAR TİPİ PROJEKTÖR 09.2154

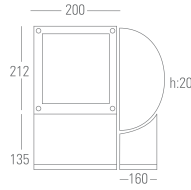

09.2106

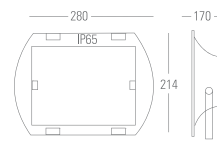

- Alüminyum Enjeksiyon Gövde
- Temperli Cam
- Duvar Tipi Projektör
- Duy: RX7s
- Ampül: CDM-TM



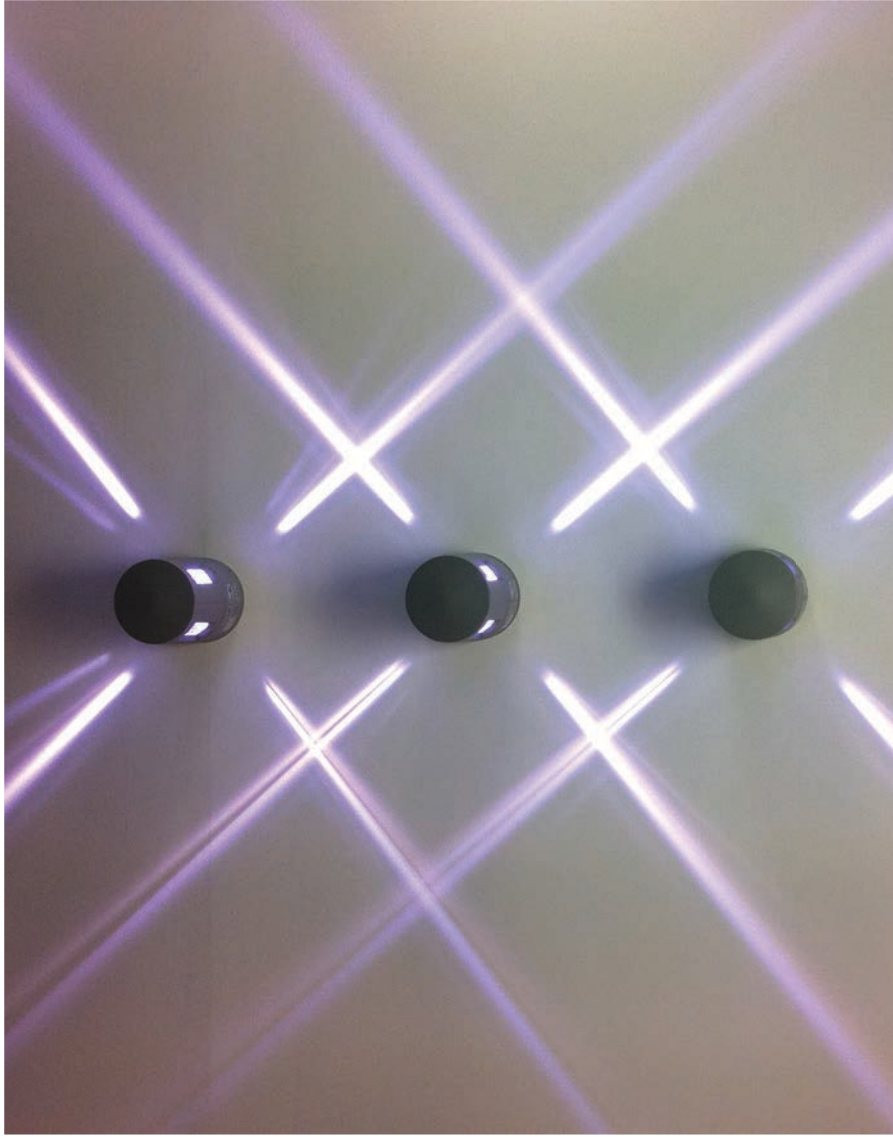

09.4570

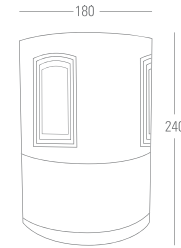

- Alüminyum Enjeksiyon Gövde
- Optik Mercek Cam
- Duvar Aplığı
- Duy: G12
- Sıva Üstü
- Ampül: CDM-T



# HARİCİ ARMATÜRLER

09.6046

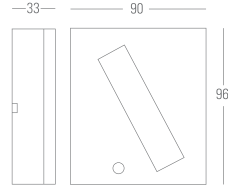

09.6047

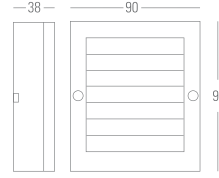

09.4593

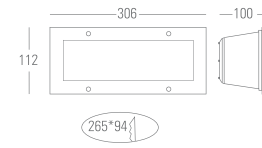

09.4594

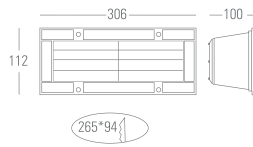

- Alüminyum Enjeksiyon Gövde
- Tamperli Kumlu Cam
- Duvar Gömme
- Duy: E27/G24/G4
- Ampül: PLC / Halojen



09.4290



09.4297

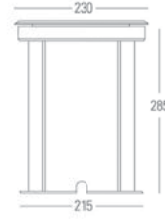

09.4298

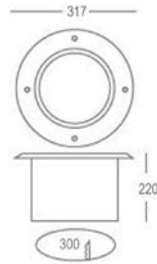

09.4299

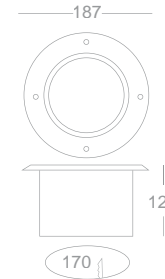

- Alüminyum Enjeksiyon Gövde
- Tamperli Kumlu Cam
- Polycarbon Muhafaza
- Zemin Gömme
- Duy: G12/ RX7s / G53
- Ampül: CDM-T/CDM-TD

# HARİCİ PROJİKTÖR

09.2133

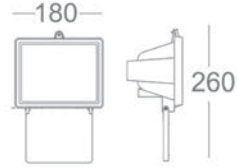

09.2132

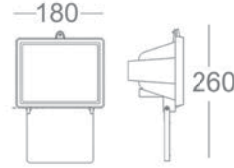

09.2130

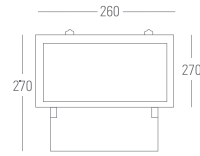

09.2134

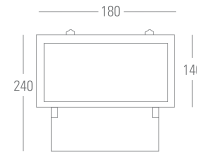
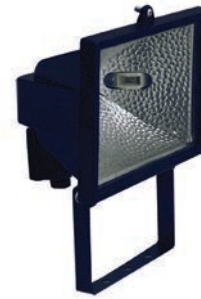

09.2126

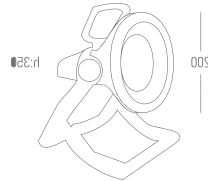

- Alüminyum Enjeksiyon Gövde
- Tamperli Kumlu Cam
- Projektör
- Duy: E27/ R7s
- Ampül: PLC/ Halojen

R7s  
E27 | F | | 0,5m | | IP54

09.2142

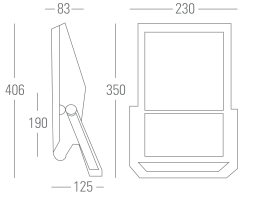

150 W



09.2117

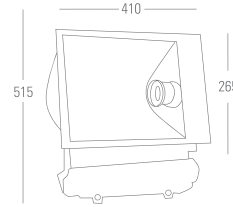

400 W



09.2144

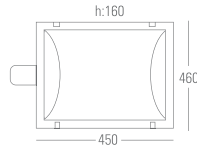

1000 W



09.2145

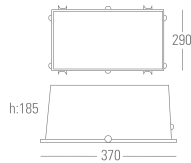

- Alüminyum Enjeksiyon Gövde
- Tamperli Kumlu Cam
- Projektör
- Duy: E40/ R7Xs
- Ampül: Matal halide

⚡ | ⚙ | ⓪0,5m | 🏠 | IP65



# HARİCİ ARMATÜRLER

09.1229

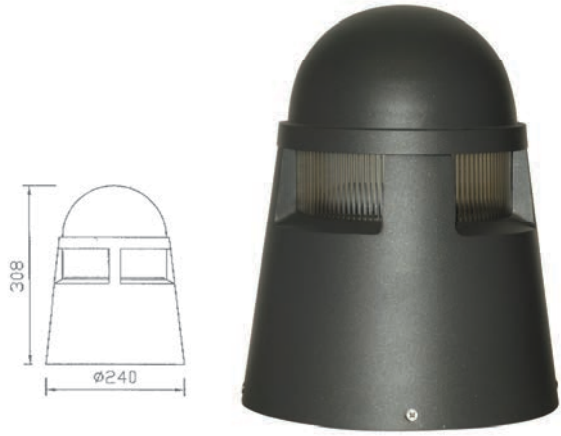

09.1758

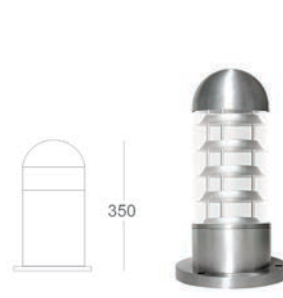

09.1726

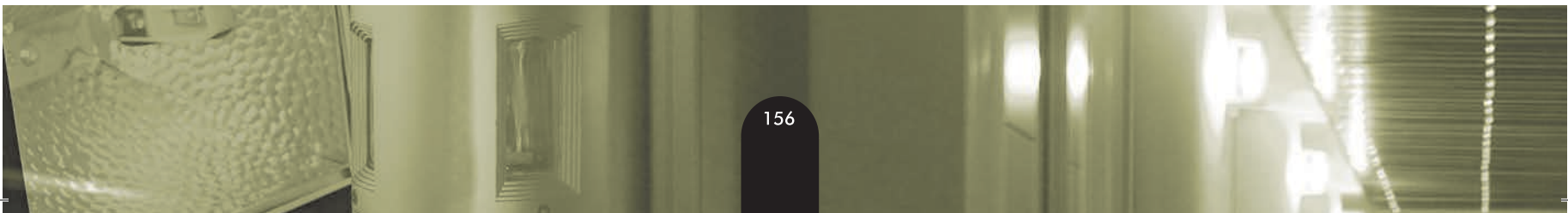

09.1729



09.1766

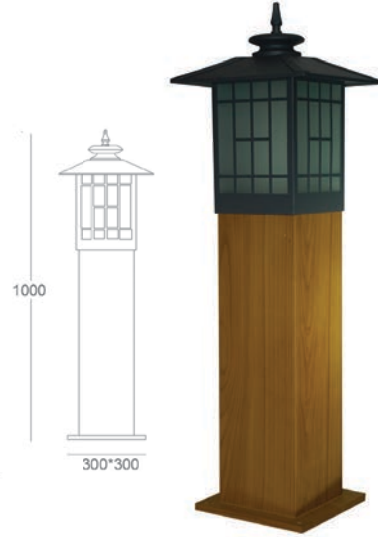

09.1723

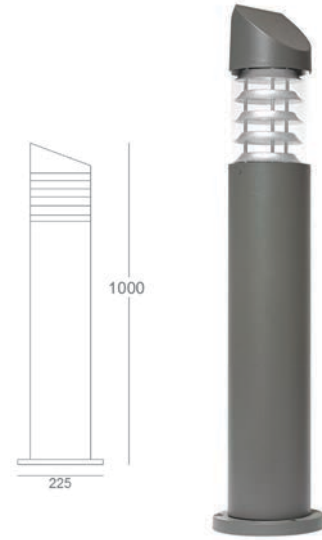

09.1728

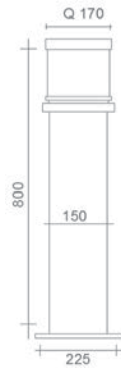

09.1738

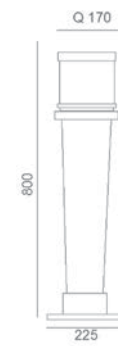

- Alüminyum Enjeksiyon Gövde
- Tamperli Kumlu Cam
- Bollard
- Duy: E27
- Kolay Montaj
- Ampül: Enerji Tasarruflu

S T U D I O  
*B*ESTAR  
L I G H T I N G

*B*ESTAR.com.tr





## BANT ARMATÜR

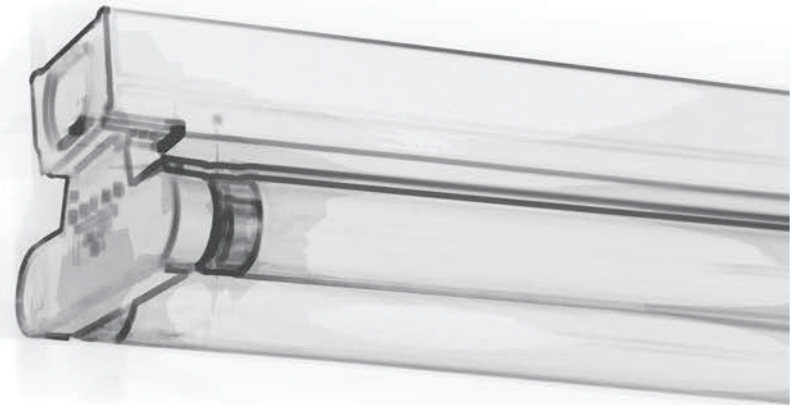

# BANT ARMATUR



12.3451

2x36W T8 TMS Elektronik Balastlı

12.3450

1x36W T8 TMS Elektronik Balastlı

12.3452

1x18W T8 TMS Elektronik Balastlı

12.3453

2x18W T8 TMS Elektronik Balastlı

T8

- DKP Saç Gövde
- Fırın Boyalı
- Elektronik Balastlı
- Ampül: T8 Flourasant
- MAX:18-36W
- Kullanım Alanları:  
Ofis, Mağaza, Outlet,  
Depo ve Üretim Alanları.



**12.3467** 1x35W T5 Reflektörlü Elektronik Balastlı Armatür

**T5**

**12.3470** 1x28W T5 Reflektörlü Elektronik Balastlı Armatür

**12.3459** 1x54W T5 Reflektörlü Elektronik Balastlı Armatür

**12.3460** 2x28W T5 Reflektörlü Elektronik Balastlı Armatür

**12.3466** 2x21W T5 Reflektörlü Elektronik Balastlı Armatür

**12.3461** 2x14W T5 Reflektörlü Elektronik Balastlı Armatür

**T5**

**12.3480** 1x35W T5 Elektronik Balastlı Armatür

**12.3459** 1x54W T5 Elektronik Balastlı Armatür

**12.3454** 1x28W T5 Elektronik Balastlı Armatür

**12.3455** 1x21W T5 Elektronik Balastlı Armatür

**12.3456** 1x14W T5 Elektronik Balastlı Armatür

**12.3457** 1x8W T5 Elektronik Balastlı Armatür

**T5**

**12.3462** 1x28W T5 Difüzörlü Armatür

**12.3463** 1x21W T5 Difüzörlü Armatür

**12.3464** 1x14W T5 Difüzörlü Armatür

**12.3465** 1x8W T5 Difüzörlü Armatür

**T5**





STUDIO  
*B*ESTAR  
LIGHTING

*B*ESTAR.com.tr

## TAVAN ARMATÜR



# TAVAN ARMATÜRLER

10.5308

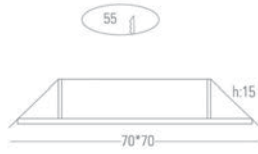

10.5360



10.3296



10.3293

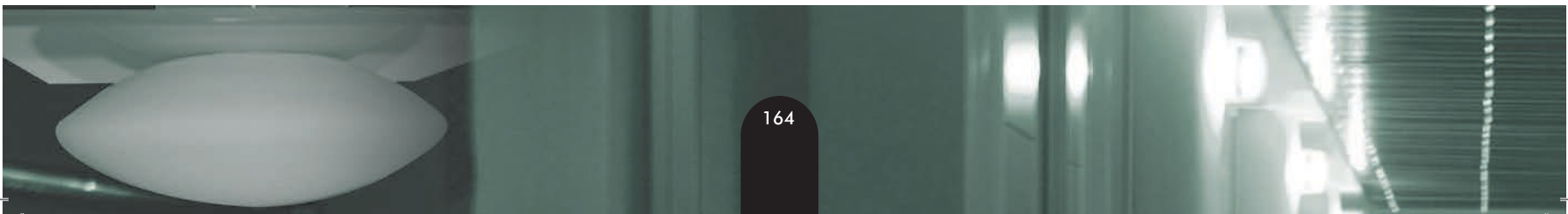



10.6013



10.6030



- Metal Gvde
- Renkli Cam
- Trafo
- Duy GU5.3



STUDIO  
*B*ESTAR  
LIGHTING

*BESTAR*.com.tr

## VINTAGE SPOTLAR

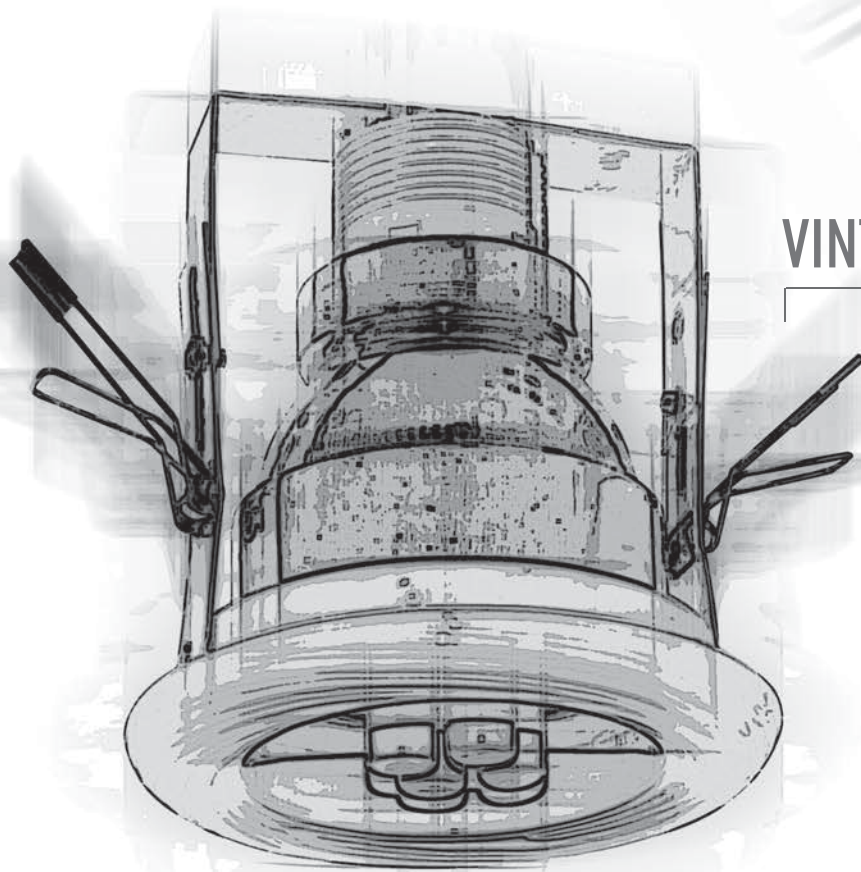

# VINTAGE SPOTLAR

---



03.4705-SARKIT

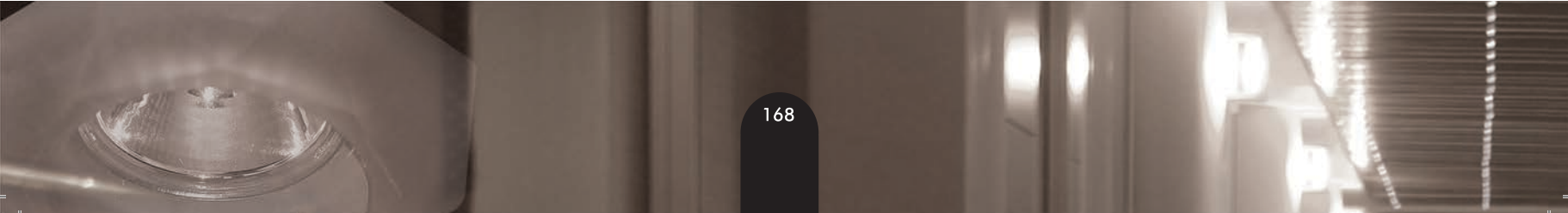

03.4701



03.4702



03.4705

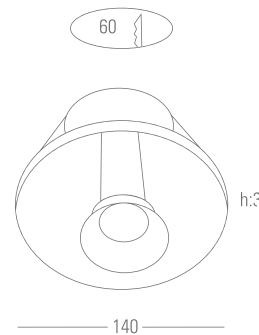

- Krom Kaide
- Şeffaf ve Renkli Cam
- Opsiyonel Aksesuar
- Duy: GU10
- MAX:50W
- Kullanım Alanları:  
Ev, Ofis, Villa,  
Özel Alanlar

| F | ⊕ | 0,5m | 🏠 | IP20 |

# VINTAGE SPOTLAR

Geçmişten Geleceğe

01.1045

LED



01.1060

LED

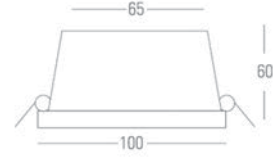

01.1020B

LED

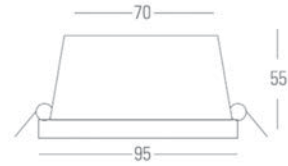

01.1020W

LED

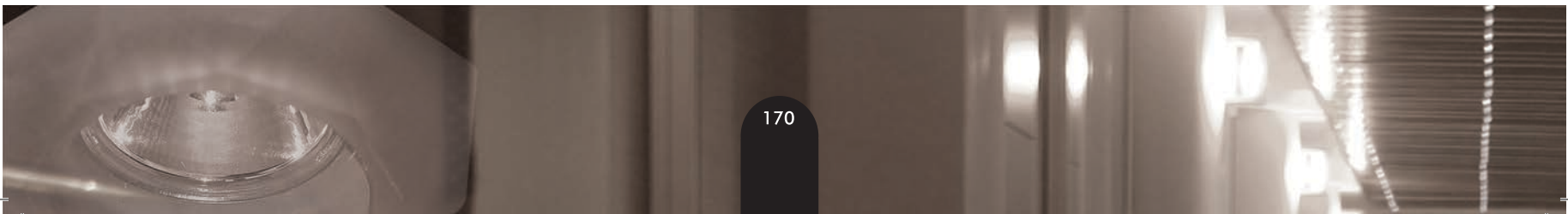

## 01.1032W

LED

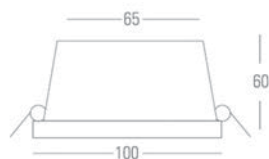

## 01.1032B

LED



- Metal Gvde
- Renkli Cam
- Elektronik Trafoya Uygun
- LED Ampule Uygun
- Halojen Ampule Uygun



## 01.1027W

## 01.1027B

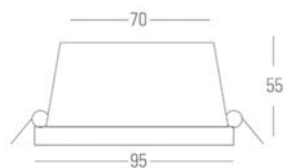

# VINTAGE SPOTLAR

00.0022

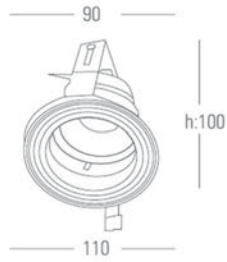

00.0020

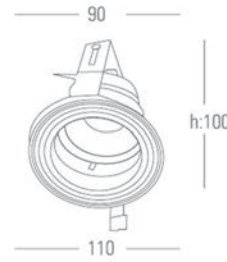

- Metal Gövde
- Renkli Cam
- Elektronik Trafoya Uygun
- Duy: G24d
- PLC Ampul

G24d | MAX 13W | F | ⚡ | 0,5m | IP20

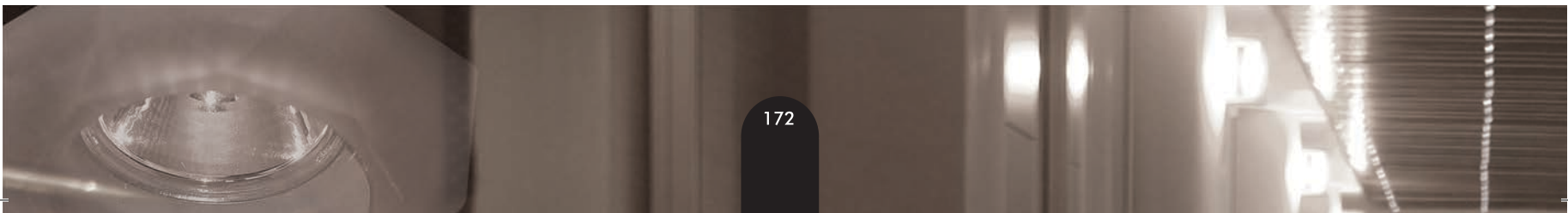

03.4005

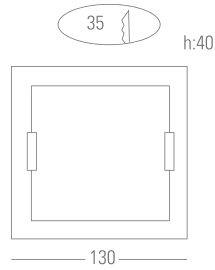

03.4000

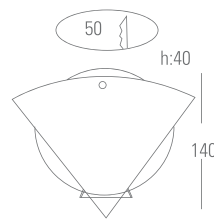

03.4045

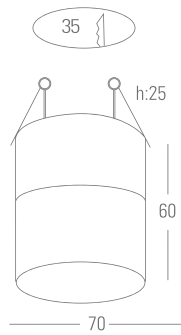

03.4066



03.0160

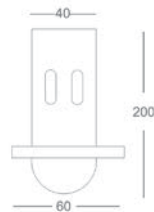

- Metal Gvde
- Renkli Cam
- Elektronik Trafoya Uygun
- Duy: G4
- Halojen Ampul

# VINTAGE SPOTLAR

02.1137



02.1138



02.1139

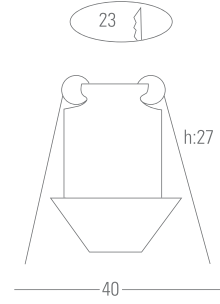

02.1142



02.1143



02.1145

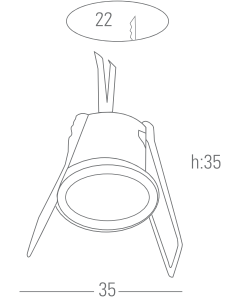

Led uygulamaları için  
lütfen bilgi alınız.

02.1107



02.1110

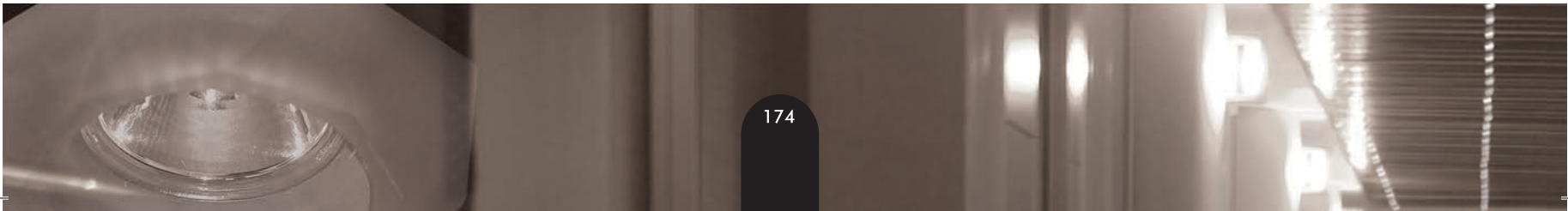
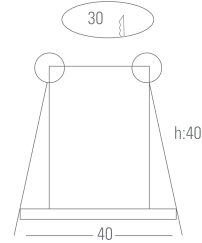

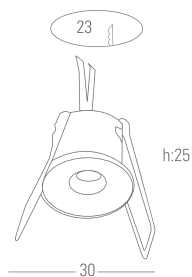

02.1140



02.1133



02.1135



02.1136



Led uygulamaları için  
lütfen bilgi alınız.

- Yıldız Spot
- Zamak Gövde
- Elektronik Trafoya Uygun
- Duy: G4
- Ampül: Kapsül
- MAX: 10-20W
- Kullanım Alanları:  
Ev, Ofis, Mağaza,

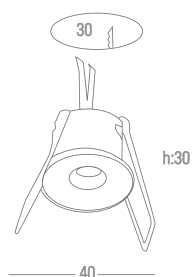
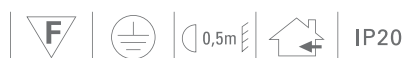

02.1126



02.1124



02.1130



02.1120



BESTAR.com.tr

# CAM SPOTLAR

Enerji Tasarruflu Ampül

03.4027



03.4028



03.4325

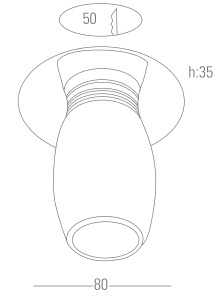
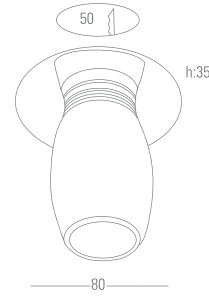
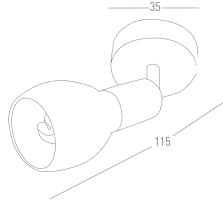

03.4326

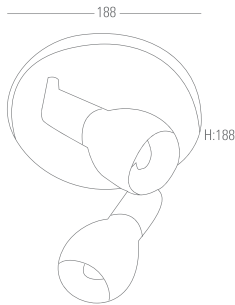

- Alüminyum Kaide
- Şeffaf Cam
- Elektronik Trafoya Uygun
- Duy: GU10
- MAX: 9-11W
- Kullanım Alanları:  
Ev, Ofis, Villa,  
Özel Alanlar

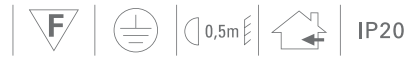

03.4329



H:135

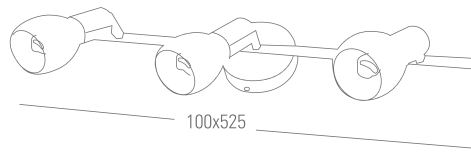

100x525

03.4328



H:135

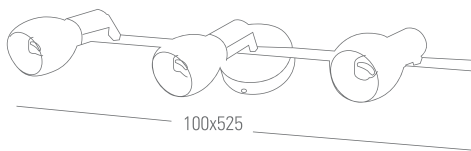

100x525

03.4327



233

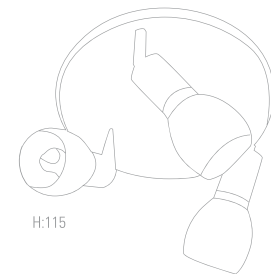

H:115

BESTAR.com.tr

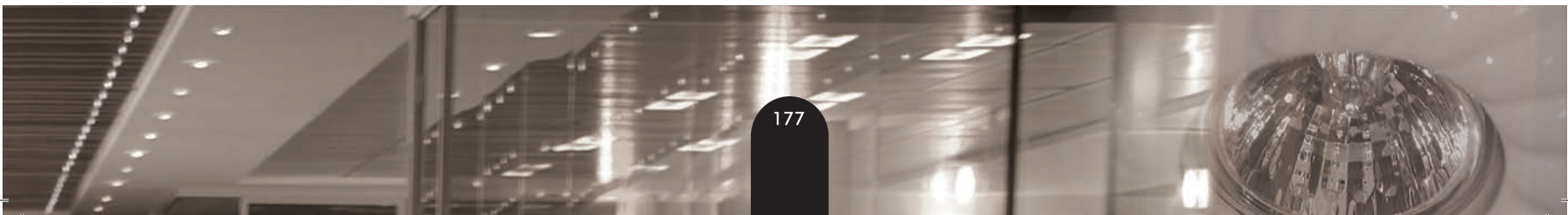

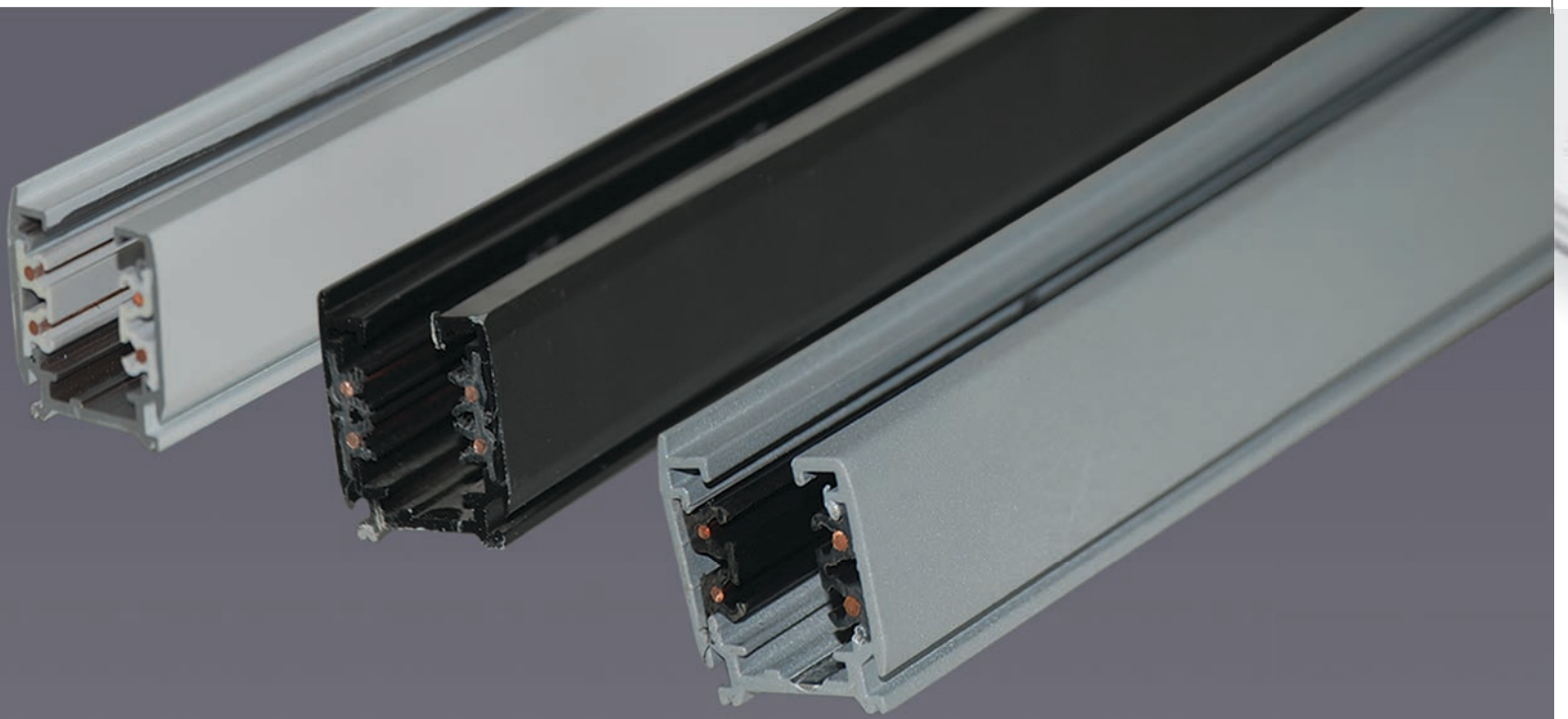

STUDIO  
*B*ESTAR  
LIGHTING

*B*ESTAR.com.tr

## RAY VE KOMPONENTLER

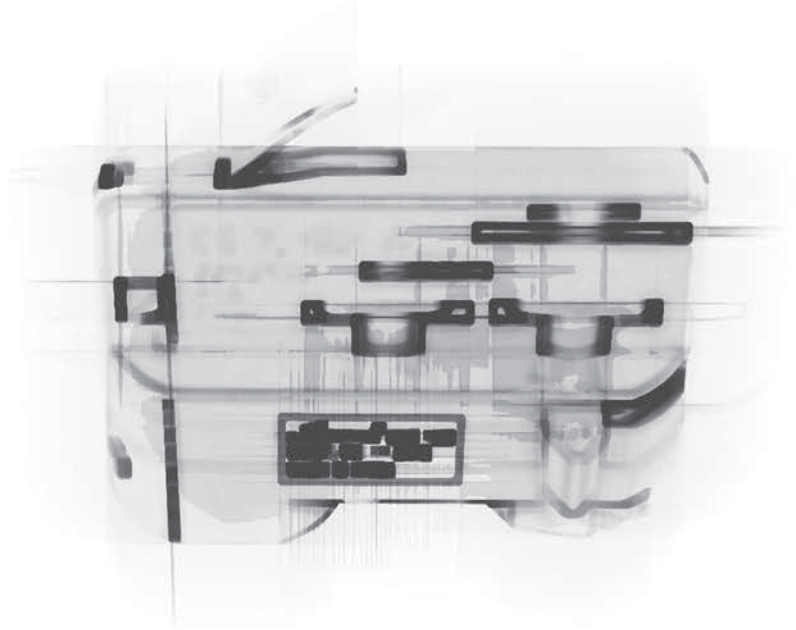

# RAYLAR VE AKSESUARLARI



**11.8040** MONOFAZE SOKET

**11.8042** TRİFAZE 2 MT RAY

**11.8043** TRİFAZE 3 MT RAY

- Alüminyum Gövde
- İzole Edilmiş Bakır İletken

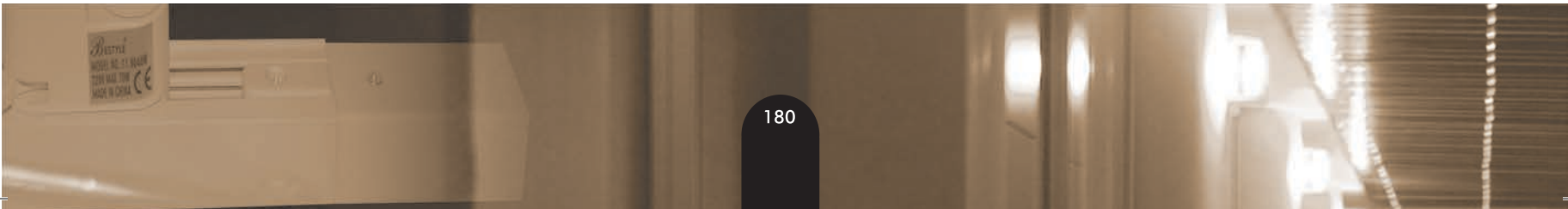



11.8021 TRİFAZE 1 MT RAY

11.8022 TRİFAZE 2 MT RAY

11.8023 TRİFAZE 3 MT RAY



11.8035 RAY ASKI TAKIMI

## TRİFAZE RAY SOKETİ



11.8020

11.8020 W

11.8020 B

Renkler:   

## ENERJİ GİRİŞİ



11.8025

11.8025 W

11.8025 B

SAĞ



11.8026

11.8026 W

11.8026 B

SOL

## TRİFAZE RAY ARA BAĞLANTI



11.8027

## TRİFAZE KÖŞE DÖNÜŞLERİ



11.8031

11.8031 W

11.8031 B

SAĞ

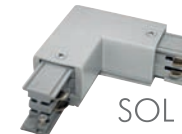

11.8030

11.8030 W

11.8030 B

SOL

## TRİFAZE RAY SON KAPAK



11.8028

# ELEKTRONİK TRAFÖ VE BALASTLAR

70W METAL HALDE BALAST

20.2240-70



KOD	AMPÜL(W)	HID(A)	VOLTAJ	F/Hz.	$\lambda$	$\mu$	$t_c$ (°C)	ÖLÇÜ mm
020.2240-70	70W	0,38A	220-240V	50	>0.90	>95%	75	110x75x33

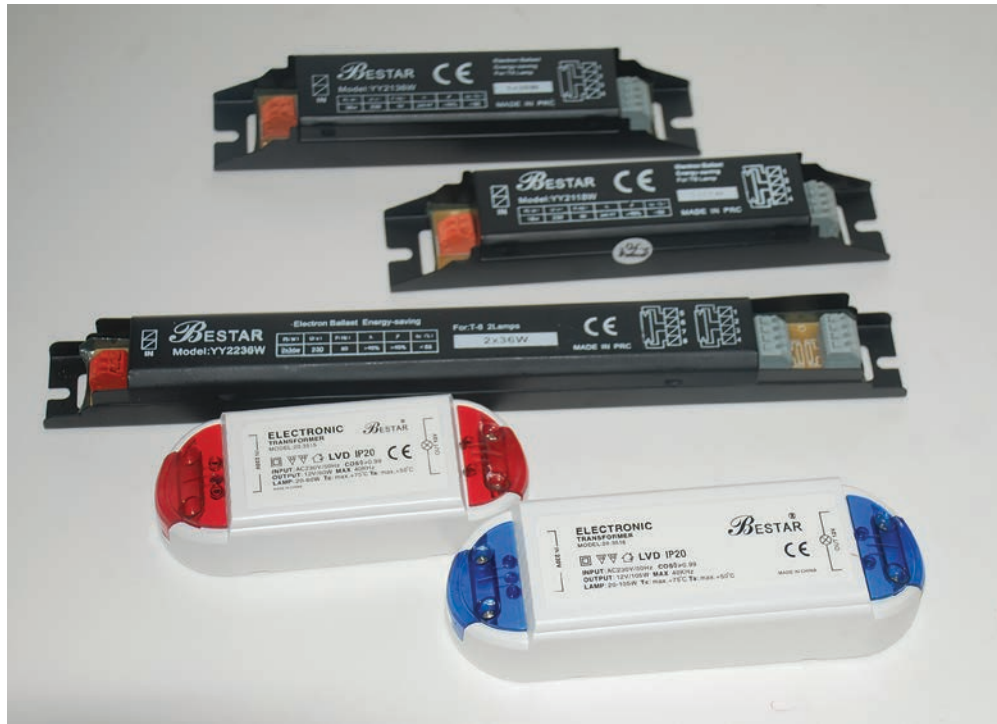

- Elektronik Halojen Trafo
- Elektronik Balast T8 FL.

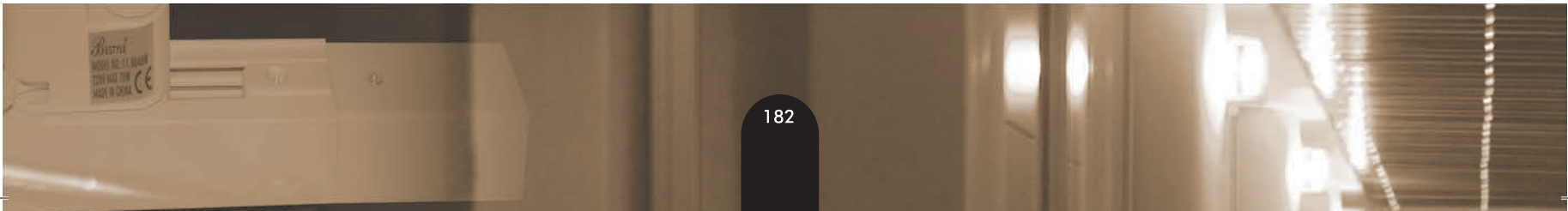

20.3515



## ELEKTRONİK TRAFÖ 60W

- Giriş: AC 230v.50Hz. CosØ>0.99
- Çıkış:12v.60w Max: 40 KHz
- Tc:max +75°C Ta:Max+50°C
- LVD-CE Belgeli IP20 Korunmalı
- Giriş Çıkış Klemensli ve Kapaklı

20.3516



## ELEKTRONİK TRAFÖ 105W

- Giriş: AC 230v.50Hz. CosØ>0.99
- Çıkış:12v.105w max: 40 KHz
- Tc:Max +75°C Ta:Max+50°C
- LVD-CE Belgeli IP20 Korunmalı
- Giriş Çıkış Klemensli ve Kapaklı

20.3532

2x36W T8 ELEKTRONİK BALAST



1x18W T8 ELEKTRONİK BALAST

20.3530



20.3531

1x36W T8 ELEKTRONİK BALAST



KOD	AMPÜL(W)	VOLTAJ	F/Hz.	$\lambda$	$\mu$	tc (°C)	ÖLÇÜ mm
20.3530	T8 1x18W	230	50	>0.97	>95%	<55	170x33x30
20.3531	T8 1x36W	230	50	>0.97	>95%	<55	170x33x30
20.3532	T8 2x36W	230	50	>0.98	>95%	<55	275x33x30

BESTAR.com.tr

# HOPARLÖR KAPAĞI

20.7010

HOPERLÖR KAPAĞI 3'

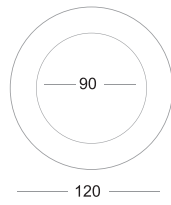

20.7011

HOPERLÖR KAPAĞI 4'

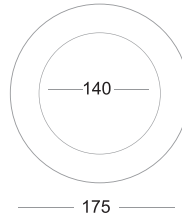

20.7012

HOPERLÖR KAPAĞI 5'

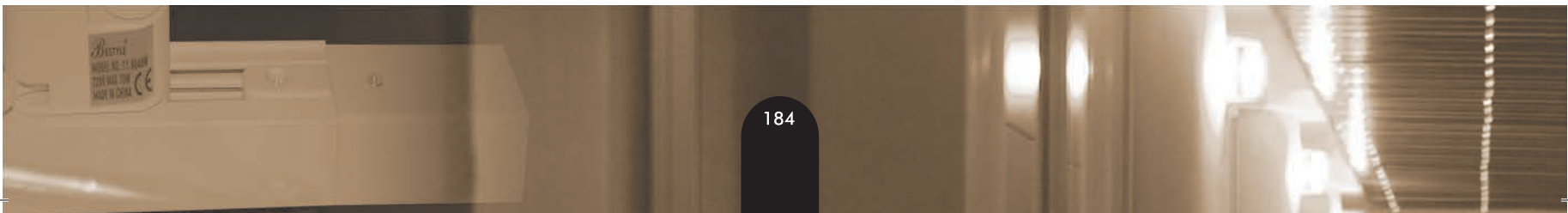
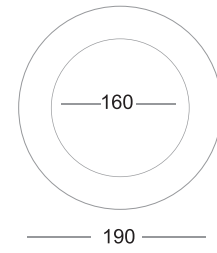

# MEKANİK BALAST KİT

20.3520 70W METAL HALDE KİT



150W METAL HALDE KİT 20.3521



20.3522 250W METAL HALDE KİT



400W METAL HALDE KİT 20.3523



KOD	AMPÜL	AKIM	$\Delta T$	CAPASİTOR	V/Hz	ÖLÇÜLER mm	AĞIRLIK
020.3520	70W	1,00	1,00	12	230/50	125x120x55	1,65
020.3521	150W	1,80	1,80	20	230/50	170x650x55	2,50
020.3522	250W	3,00	3,00	32	230/50	170x950x60	3,30
020.3523	400W	3,40	3,40	30	230/50	210x950x60	3,40

# INDEX

01	<b>KRİSTAL SPOTLAR</b>	
	03.4396-03.4387-03.4395-03.4400-03.4410	06-07
	03.4393-03.4385-03.4386-03.4380-03.4379 03.4394-03.4381-03.4377-03.4375-03.4383 03.4392-03.4372-03.4370-03.4382-03.4390 03.4391-03.4389-03.4388-03.4359-03.4363 03.4361-03.4378-03.4358	08-13

02	<b>HALOJEN CAM SPOTLAR</b>	
	03.4720E-03.4720-03.4721-03.4235-03.4236 03.4238-03.4006-03.4015-03.4016-03.4010 03.4231-03.4232-03.4251-03.4252	16-19
	03.4760-03.4020-03.4766-03.4762-03.4009 03.4222-03.4220-03.4712-03.4257-03.4715 03.4716-03.4717-03.4240-03.6021	20-23
	03.4364A-03.4224-03.4364-03.4764-03.4725 03.4037-03.4726-03.6025G-03.6025-03.0163 03.0161-03.4723-03.4763-03.4767	24-27

03	<b>HALOJEN SPOTLAR</b>	
	02.4110-04.4111-04.4112-04.4113-04.4115 02.4116-02.4114-02.4117-02.4118-02.4119 02.4167-02.4565-02.4060	30-33
	02.4126W-02.4127W-02.4126-02.4127 02.4130-02.4129-02.4053-02.4120-04.4121 04.4122-04.4123-04.4124-02.4125-04.4103 04.4104-04.4137-04.4138-04.4108-04.4105	34-37
	02.4100-02.4101-02.4156-02.4054-02.4155 02.4132-02.4176-02.4173-02.4175-02.4174 02.1094-02.1091-02.1150-02.1151-02.1162 02.1160-02.4086-02.5361-02.4091-02.5360 02.5381-02.1177-02.1172	38-41
	02.4631-02.4632-02.0165-02.5365-02.5366 02.5370-02.5377-02.4340-02.4346-02.4063S 02.4063B-02.4064G-02.4064B-02.4067	42-45

04	<b>PROFESYONEL AYDINLATMALAR</b>	
	06.4519-06.4509-06.4509-06.4517-06.4471 06.4444-06.4460-06.4447-06.4440B- 06.4440W-06.4752-06.4513-06.4453-06.4443 06.4452-06.4466-06.4520-06.7009-06.4518 06.2170-06.7007-06.7007B	50-59
	06.4248-06.4248G-06.4614B-06.4614W 06.4615G-06.4615W-06.2019-06.2018 06.4245-06.4246-06.4616-06.4501-06.4500 06.4502R-06.4501R	60-63
	06.4401-06.4402-06.4413-06.4424-06.4414 06.4432-06.4431-06.4433	64-65
	06.2021-06.2022-06.2024-06.2020-06.2045 06.2012-06.2183-06.4637-06.4638-06.4609 06.4613-06.4530-06.2053-06.2057-06.2027 06.4109-06.4612-06.4611-06.4610	66-71
	06.4650-06.4655-06.4656-06.4657	72-75

04	<b>PROFESYONEL AYDINLATMALAR</b>	
	06.4546-06.4547-06.4548-06.4603-06.4600 06.4601-06.4602-06.4522-06.4521-06.4526 06.4531-06.4605-06.4606-06.4607-06.4621 06.4622-06.4623-06.6034S-06.6034G 06.6037-06.6038-06.6036	76-85
	00.0060-00.0061-00.0062-00.0065-00.0066 00.0067-00.0068-00.0027-00.0027-1- 00.0027-2-00.0028-00.0028-1-00.0028-2- 00.0090-00.0089-00.0023-00.0024	86-93
	00.0070-00.0071-00.0073-00.0105-00.0106 00.0082-00.2027-00.2521-00.2531-00.2501 00.0059-00.0110-00.0094-00.0097-00.0053 00.0054-00.0088-00.0050	94-98
	00.2092-00.2093-00.2094-00.2096-00.2089 00.2089-00.2090-00.2091-00.2086-00.2087 00.2088-00.2080-00.2081-00.2082-00.2083 00.2084-00.2085-00.2070-00.2071	99-101
	B1120-T5 / B1120-LED / B1120T5 - CDM R111	102-103

05	<b>LED AYDINLATMA</b>	
	04.0056-06.4610L-06.4546L-06.04.0015 04.0055-04.0202-02.4173L-02.4175L 02.4174L-02.1094L-02.4240L-02.1091L 02.0161L-02.0163L-02.04.4090-04.4098 04.4099-04.5512-04.5511-04.5555-02.4041L 02.4042L-02.4043L-02.4044L-02.4086L 02.4091L02.5381L-02.5361L-02.5360L 02.1177L-02.1172L	106-113
	06.4509L-04.6080L-06.4246L-06.4245L- 06.2019L-04.6070-04.0010-04.6054 03.4327-03.4328-03.4329-04.6078-04.6010 04.4094-04.4093-04.4093SÜ-04.1050G- 04.1050B-04.4745-04.4746-04.1191-04.1190 04.4147-04.4149-04.4072-04.4073-04.4074	114-123
	04.4270-04.4271-04.4275-04.4276-04.6068 04.6068-1/04.6068-2/04.6068-3 /04.6068-4 04.6067/04.6067-1/04.6067-2/03.4503GL 03.4503BL-09.1210L-04.8057-09.4291L 09.4314L-04.6090L-09.4315L-09.4293 09.4293-09.4293T-09.4293S-09.4298L 09.4299L-09.4278L-09.4279L-04.6075-09.6069	124-131
	04.8058-04.2105-04.2104-04.B9030MC-04. B9030RGB-04.B9030.1/10V-04.B9030.DMX- 04.9031MC-04.9031RGB- 04.9031.1/10V-04.9031.DMX-04.9032MC- 04.9032RGB-04.9032.1/10V-04.9032.DMX- 013.1260-013.1250-013.1209- 013-1210-013.1211	132-135
	04.6001-04.6004-04.6002-04.6007-04.6005 04.6008-04.6011-04.6012-04.6013-04.6014 04.6015-04.6016-04.6017-04.6018-04.6019 04.6022-04.7031-04.7030-04.7036-04.7035 04.7038-04.7037-04.4096-04.4097-04.5094 04.5095-04.5097-04.5098-04.4735-04.4736 04.4737-04.4728-04.4732-04.4730-04.4731 04.4733-04.4734	136-139
	04.7001-04.7002-04.7005-04.7006-04.7003 04.7004	142-143

06

07

**HARİCİ ARMATÜRLER**

09.4568-09.4569-09.4566-09.4567-09.4586  
09.2188-09.2187-09.2189-09.2186-09.4554  
09.4591-09.3369-09.3372-09.3376-09.3380  
09.2119-09.2150-09.1297-09.4294-09.2154  
09.2106-09.4570

146-151

09.6046-09.6047-09.4594-09.4593-09.4290  
09.4298-09.4297-09.4299-09.2133-09.2130  
09.2132-09.2134-09.2126-09.2142-09.2117  
09.2144-09.2145

152-155

09.1229-09.1758-09.1726-09.1729-09.1766  
09.1723-09.1728-09.1738

156-157

08

**BANT ARMATÜR**

12.3451-12.3450-12.3452-12.3453-12.3467  
12.3470-12.3459-12.3460-12.3461-12.3480  
12.3459-12.3454-12.3455-12.3456-12.3457  
12.3462-12.3463-12.3464-12.3465

160-161

09

**TAVAN ARMATÜR**

10.5308-10.560-10.3296-10.3293-10.6013  
10.6030

164-165

10

**VINTAGE SPOT**

03.4701-03.4702-03.4705-01.1045-01.1060  
01.1020B-01.1020W-01.1032W-01.1032B  
01.1027W-01.1027B-00.0022-00.0020  
03.4005-03.4045-03.0160-03.4000-03.4066  
02.1137-02.1138-02.1139-02.1142-02.1143  
02.1145-02.1107-02.1110-02.1140-02.1133  
02.1135-02.1136-02.1126-02.1130-02.1124  
02.1120-02.1120-03.4325-03.4326-03.4027  
03.4028-03.4329-03.4328-03.4327

168-177

11

**RAY ve KOMPONENTLER**

11.8040-11.8042-11.8043-11.8021-11.8022  
11.8023-11.8020-11.8020W-11.8020B  
11.8025-11.8025W-11.8025B-11.8026  
11.8026W-11.8026B-11.8027-11.8028  
11.8031-11.8031W-11.8031B-11.8030  
11.8030W-11.8030B-11.8035

180-181

20.2240/70-20.3515-20.3516-20.3532-  
20.3530-20.3531-20.7010-20.7011-20.7012  
20.3520-20.3521-20.3522-20.3523

182-185

STUDIO  
*B*ESTAR  
LIGHTING

*B*ESTAR.com.tr

